



# Operation Manual

PRODUCT NAME

## Electric Actuator / Rod Type

MODEL / Series

### LEY Series

Applicable models: LEY[], LEYG[],

**LEY Series**  
(Rod type)

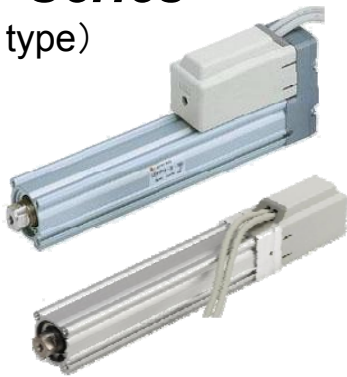

**LEYG Series**  
(Guide Rod type)

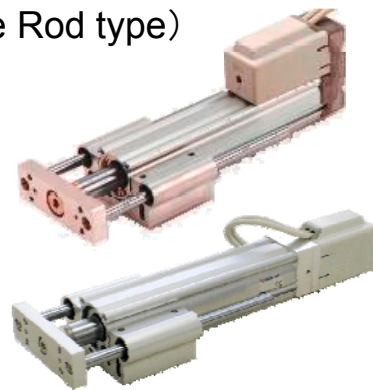

<Controller>  
**LEC□6 Series**



This manual describes the actuators operation in combination with the LEC\*6 series controllers. Refer to the manual relevant to the controller being used for full operating instructions.

# SMC Corporation

<b>Safety Instructions</b> .....	<b>2</b>
<b>1. Procedure before operation/simple setting to use straight away</b>	<b>4</b>
1.1 Preparation .....	4
1.2 Controller setting software version.....	5
1.3 Teaching box.....	7
<b>2. Rod type / LEY Series</b> .....	<b>9</b>
2.1 Specification.....	9
2.2 How to Order .....	11
2.3 Construction .....	12
<b>3. Guide rod type / LEYG Series</b> .....	<b>13</b>
3.1 Specification.....	13
3.2 How to Order .....	15
3.3 Construction .....	16
<b>4. Product Outline</b> .....	<b>17</b>
4.1 System construction .....	17
4.2 Setting Function.....	18
4.3 Step data setting method .....	21
4.4 Parameter setting.....	32
<b>5. Wiring of cables / Common precautions</b> .....	<b>35</b>
<b>6. Electric actuators / Common precautions</b> .....	<b>36</b>
6.1 Design and selection .....	36
6.2 Mounting.....	37
6.3 Handling .....	38
6.4 Operating environment .....	39
6.5 Maintenance .....	40
6.6 Precautions for actuator with lock .....	40
<b>7. Electric actuators / Common precautions</b> .....	<b>41</b>
7.1 Design and selection .....	41
7.2 Handling .....	41
7.3 Mounting.....	44
7.4 Precaution on maintenance .....	46
7.5 Replacement of belt.....	47
<b>8. Troubleshooting</b> .....	<b>48</b>



# LEY Series / Electric Rod type Safety Instructions

These safety instructions are intended to prevent hazardous situations and /or equipment damage. These instructions indicate the level of potential hazard with the labels of "Caution," "Warning" or "Danger." They are all important notes for safety and must be followed in addition to International Standards (ISO /IEC), Japan Industrial Standards (JIS)\*1) and other safety regulations\*2).

\*1) ISO 4414: Pneumatic fluid power -- General rules relating to systems

ISO 4413: Hydraulic fluid power -- General rules relating to systems

IEC 60204-1: Safety of machinery -- Electrical equipment of machines (Part 1: General requirements)

ISO 10218-1992: Manipulating industrial robots -- Safety

JIS B 8370: General rules for pneumatic equipment.

JIS B 8361: General rules for hydraulic equipment.

JIS B 9960-1: Safety of machinery -- Electrical equipment for machines. (Part 1: General requirements)

JIS B 8433-1993: Manipulating industrial robots - Safety. etc.

\*2) Labor Safety and Sanitation Law, etc.



## Caution

Caution indicates a hazard with a low level of risk which, if not avoided, could result in minor or moderate injury.



## Warning

Warning indicates a hazard with a medium level of risk which, if not avoided, could result in death or serious injury.



## Danger

Danger indicates a hazard with a high level of risk which, if not avoided, will result in death or serious injury.

## Warning

### 1. The compatibility of the product is the responsibility of the person who designs the equipment or decides its specifications.

Since the product specified here is used under various operating conditions, its compatibility with specific equipment must be decided by the person who designs the equipment or decides its specifications based on necessary analysis and test results.

The expected performance and safety assurance of the equipment will be the responsibility of the person who has determined its compatibility with the product.

This person should also continuously review all specifications of the product referring to its latest catalog information, with a view to giving due consideration to any possibility of equipment failure when configuring the equipment.

### 2. Only personnel with appropriate training should operate machinery and equipment.

The product specified here may become unsafe if handled incorrectly.

The assembly, operation and maintenance of machines or equipment including our products must be performed by an operator who is appropriately trained and experienced.

### 3. Do not service or attempt to remove product and machinery /equipment until safety is confirmed.

The inspection and maintenance of machinery /equipment should only be performed after measures to prevent falling or runaway of the driven objects have been confirmed.

When the product is to be removed, confirm that the safety measures as mentioned above are implemented and the power from any appropriate source is cut, and read and understand the specific product precautions of all relevant products carefully.

Before machinery /equipment is restarted, take measures to prevent unexpected operation and malfunction.

### 4. Contact SMC beforehand and take special consideration of safety measures if the product is to be used in any of the following conditions.

1) Conditions and environments outside of the given specifications, or use outdoors or in a place exposed to direct sunlight.

2) Installation on equipment in conjunction with atomic energy, railways, air navigation, space, shipping, vehicles, military, medical treatment, combustion and recreation, or equipment in contact with food and beverages, emergency stop circuits, clutch and brake circuits in press applications, safety equipment or other applications unsuitable for the standard specifications described in the product catalog.

3) An application which could have negative effects on people, property, or animals requiring special safety analysis.

4) Use in an interlock circuit, which requires the provision of double interlock for possible failure by using a mechanical protective function, and periodical checks to confirm proper operation.



# LEY Series / Electric Rod type Safety Instructions

## Caution

**The product is provided for use in manufacturing industries.**

The product herein described is basically provided for peaceful use in manufacturing industries.

If considering using the product in other industries, consult SMC beforehand and exchange specifications or a contract if necessary.

If anything is unclear, contact your nearest sales branch.

## Limited warranty and Disclaimer /Compliance Requirements

The product used is subject to the following “Limited warranty and Disclaimer” and “Compliance Requirements”.

Read and accept them before using the product.

### Limited warranty and Disclaimer

**The warranty period of the product is 1 year in service or 1.5 years after the product is delivered.\*3) Also, the product may have specified durability, running distance or replacement parts. Please consult your nearest sales branch.**

**For any failure or damage reported within the warranty period which is clearly our responsibility, a replacement product or necessary parts will be provided.**

**This limited warranty applies only to our product independently, and not to any other damage incurred due to the failure of the product.**

**Prior to using SMC products, please read and understand the warranty terms and disclaimers noted in the specified catalog for the particular products.**

**\*3) Vacuum pads are excluded from this 1 year warranty.**

**A vacuum pad is a consumable part, so it is warranted for a year after it is delivered.**

**Also, even within the warranty period, the wear of a product due to the use of the vacuum pad or failure due to the deterioration of rubber material are not covered by the limited warranty.**

### Compliance Requirements

When the product is exported, strictly follow the laws required by the Ministry of Economy, Trade and Industry (Foreign Exchange and Foreign Trade Control Law).

# 1. Procedure before operation/simple setting to use straight away

The controller is shipped with the parameters appropriate to the actuator.

With the simple setting “easy mode”, it can be operated and running parameters can be changed easily.

## 1.1 Preparation

### (1) Items to be prepared

Please check on the label, and the quantity of accessories, to confirm that it is the product that was ordered.

Table 1. Componets

No.	Part name	Qty
(1)	Electric actuator / Rod type	1
(2)	Controller	1
(3)	Power supply plug	1
(4)	Actuator cable	1
(5)	I/O cable (Not use in this section)	1
(6)	Teaching box	1
(7)	Controller setting kit [The controller setting software, The communication cable, USB cable and conversion unit are included.]	1

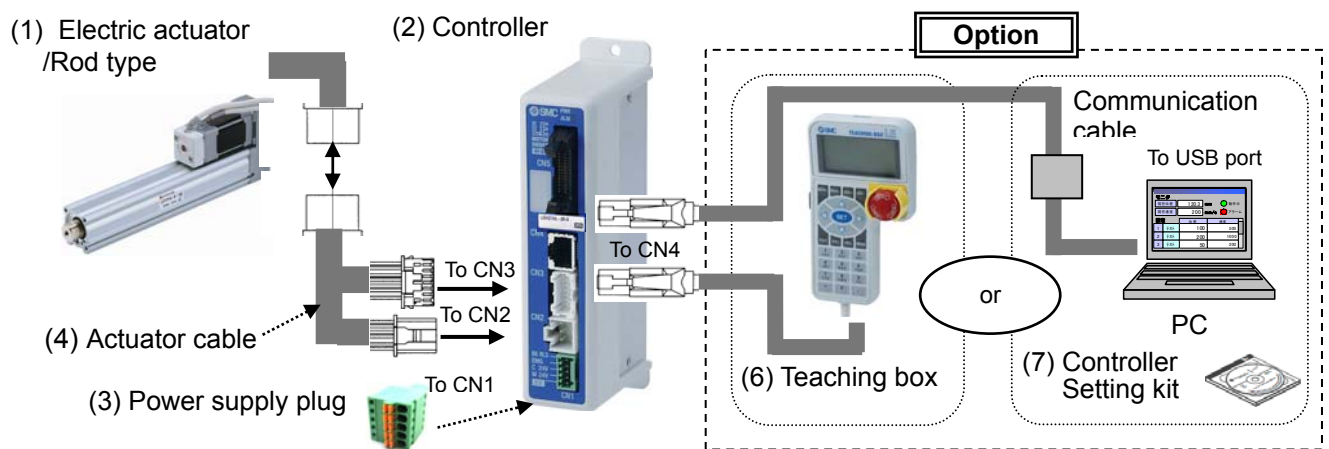

Table 2. Items to be prepared by the customer

Part name	Conditions
Power supply 24VDC Do not use the power supply with “Inruch-restraining type”	Refer to power consumption of each actuator / See 2.1 Specification[LEY] on p.9, 3.1 Specification[LEYG] on p.13 (Prepare the power supply that has capacity of “Moment max.power consumption” or more.)
Wire AWG20 (0.5mm <sup>2</sup> )	Stripped wire length  8mm
Power supply plug Wiring	<p>Connect the plus side of 24VDC to the C24V, M24V and EMG terminals of the power supply plug, and the minus side to the 0V terminal.</p> <p><u>Step motor (servo 24VDC)</u></p> <p>Push the open/close lever and insert the wire into the electrical wire entry</p> <p><u>Servo motor (24VDC)</u></p>

## 1.2 Controller setting software version

### 1. Installation of software

With the controller setting software CD-ROM, install the communication unit software, following the "Software Installation procedure" (PDF)

### 2. Startup of software

After turning on the controller power supply, start up the ACT Controller setting software

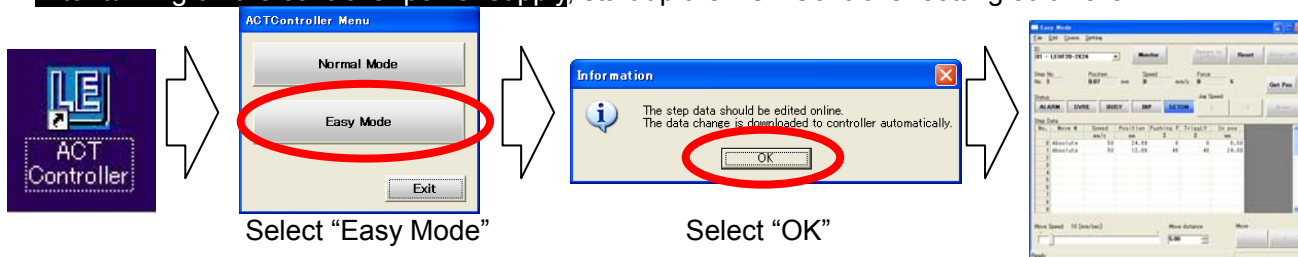

### 3. JOG Drive

a. Driving preparation: Servo On → Return to ORIG

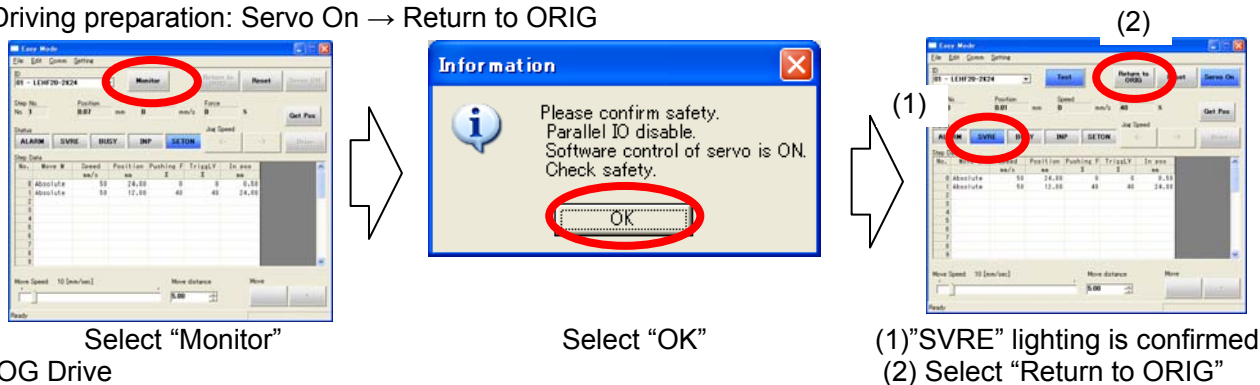

b. JOG Drive

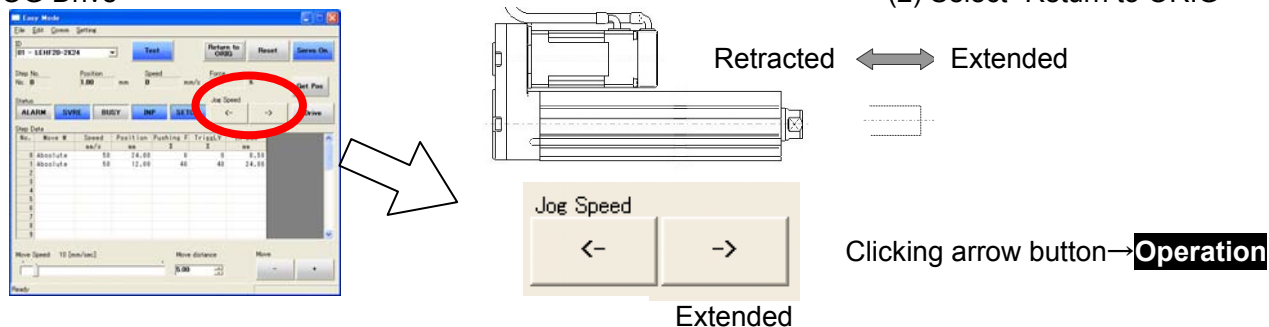

c. Driving stop: Servo Off

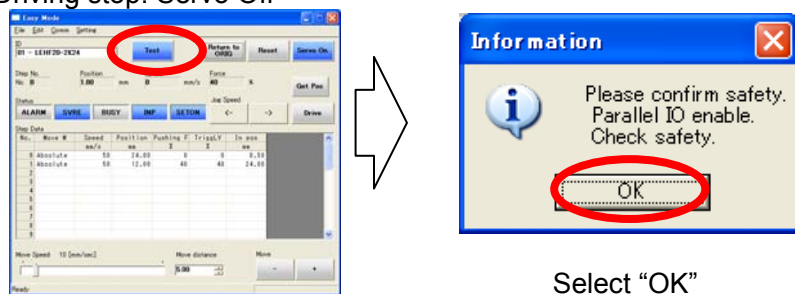

## ⚠ Caution

### If an alarm is generated

(1) When "ALARM" is generated, release it by selecting (2) Reset.

In the case of an alarm code that cannot be released with "Reset", turn the power supply OFF and ON again.

Note) For details of alarm codes, refer to the Controller Operation Manual.



#### 4. TEST Drive / Step No.0 → No.1 → No.0...

a. Driving preparation: Servo On → Return to ORIG / Refer to “3.JOG Drive”.

b. TEST Drive

“Step No.0” Operation

Procedure 1:  
Select “Step No.0”  
You can select anywhere in the row

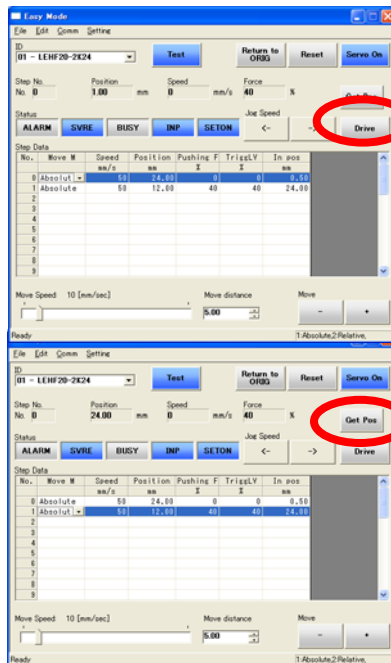

Procedure 2:  
Select “Drive”

→ **Operation**

“Step No.1” Operation

Procedure 3:  
Select “Step No.1”  
You can select anywhere in the row



Procedure 4:  
Select “Drive”

→ **Operation**

c. Driving stop : Servo Off / Refer to 3.JOG Drive.

#### 5. Step data change

Ex) “Step No.0” / Pushing operation / At the time of shipment, Step No.0 is set to pushing operation

Step Data

No.	Move M	Speed	Position	Pushing F	TriggLV	In pos
		mm/s	mm	%	%	mm
0	Absolute	250	50.00	40	40	20.00

**Change of pushing start position**

Position: 50mm → 40mm

**Change of pushing force**

Pushing force: 40% → 60%

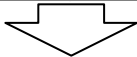

Input “40”    Input “60”

Step Data

No.	Move M	Speed	Position	Pushing F	TriggLV	In pos
		mm/s	mm	%	%	mm
0	Absolute	250	40.00	60	40	20.00

Ex) “Step No.1” / Positioning operation / At the time of shipment, Step No.1 is set to positioning operation

Step Data

No.	Move M	Speed	Position	Pushing F	TriggLV	In pos
		mm/s	mm	%	%	mm
0	Absolute	250	40.00	60	40	20.00
1	Absolute	250	0.00	0	0	0.50

**Change of positioning stop position**

Position: 0mm → 20mm

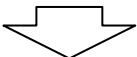

Input “20”

Step Data

No.	Move M	Speed	Position	Pushing F	TriggLV	In pos
		mm/s	mm	%	%	mm
0	Absolute	250	40.00	60	40	20.00
1	Absolute	250	20.00	0	0	0.50

For details of operation, and relationship between operation procedure and input/output signals, refer to “4.3 Step Data setting method” p. 21 to 29.

#### 6. Controller setting software screen explanation

Refer to the “Help / Easy mode” menu in the “ACT Controller” setting software.



## 1.3 Teaching box

### 1. Name

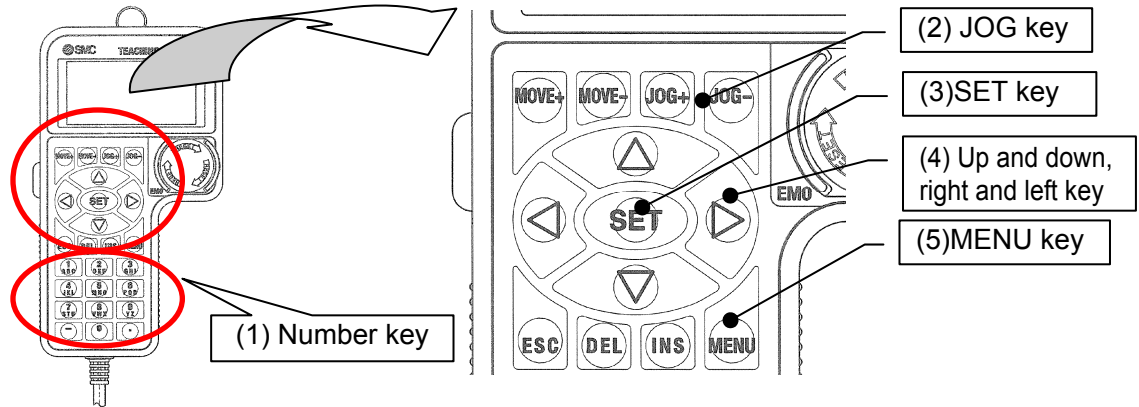

### 2. JOG Drive

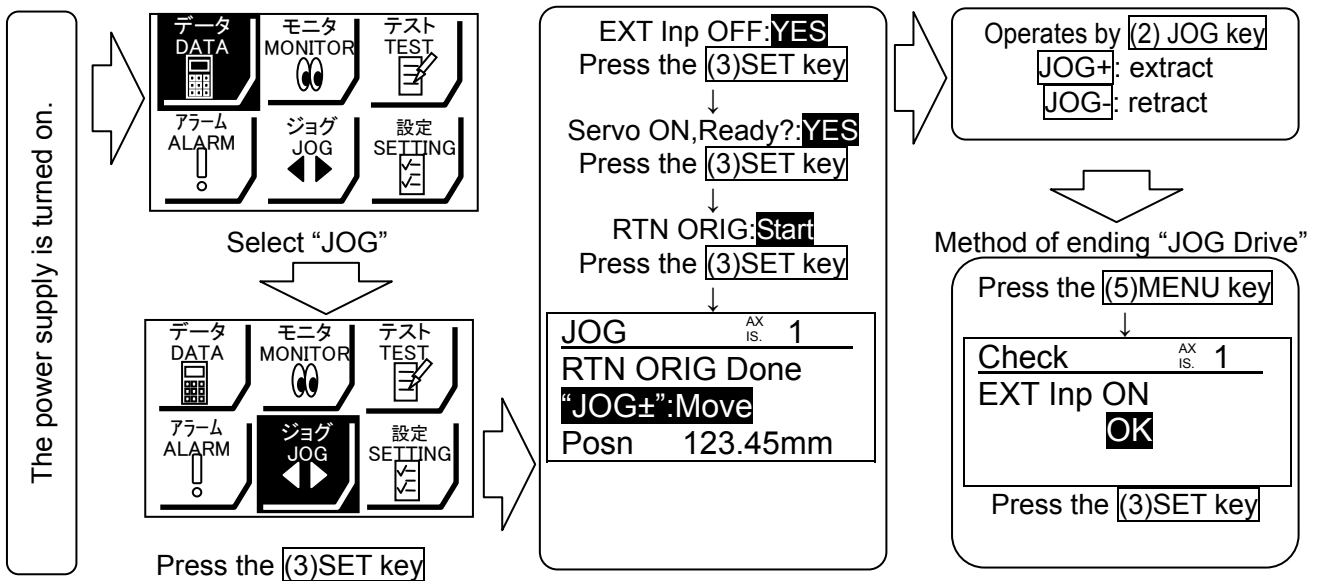

### 3. TEST Drive / Step No.0 → No.1 → No.0...

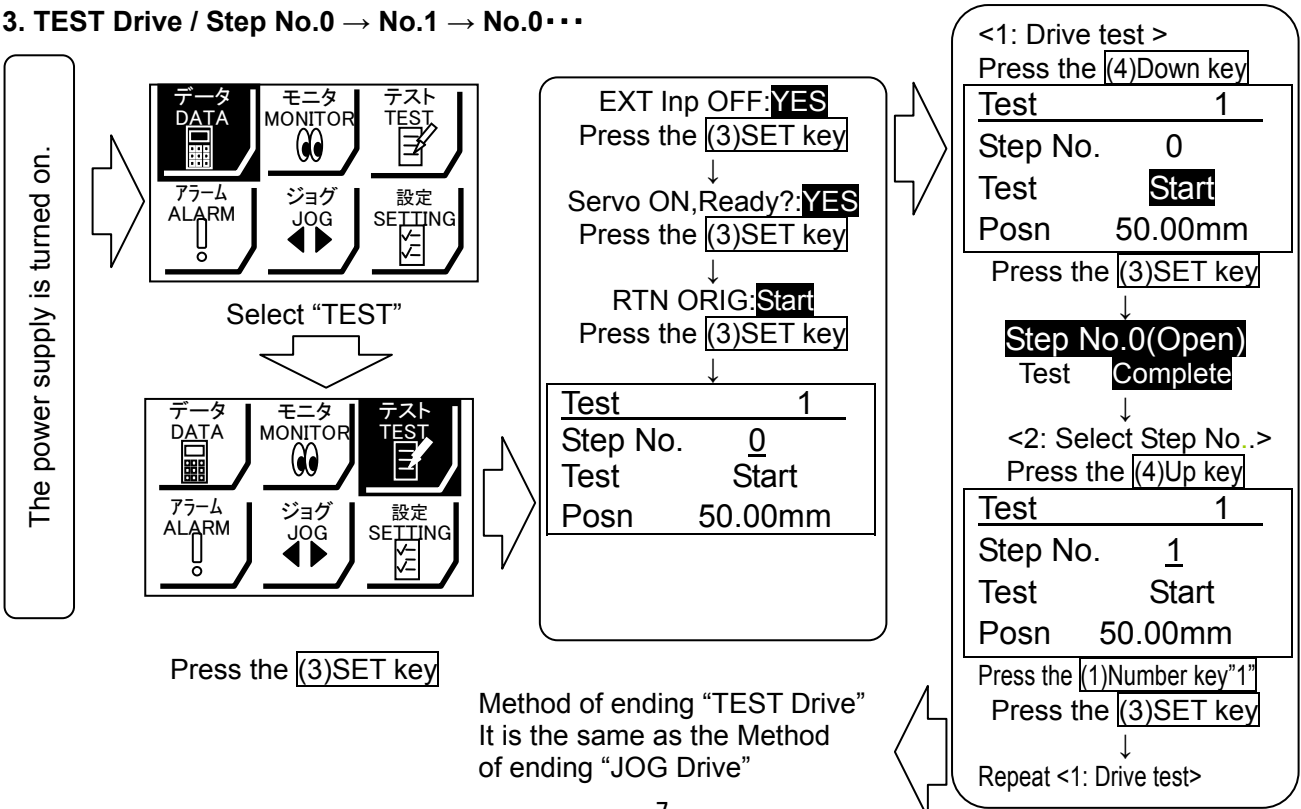



#### 4. Step data change

“Step No.0” / Pushing operation / At the time of shipment, Step No.0 is set to pushing operation

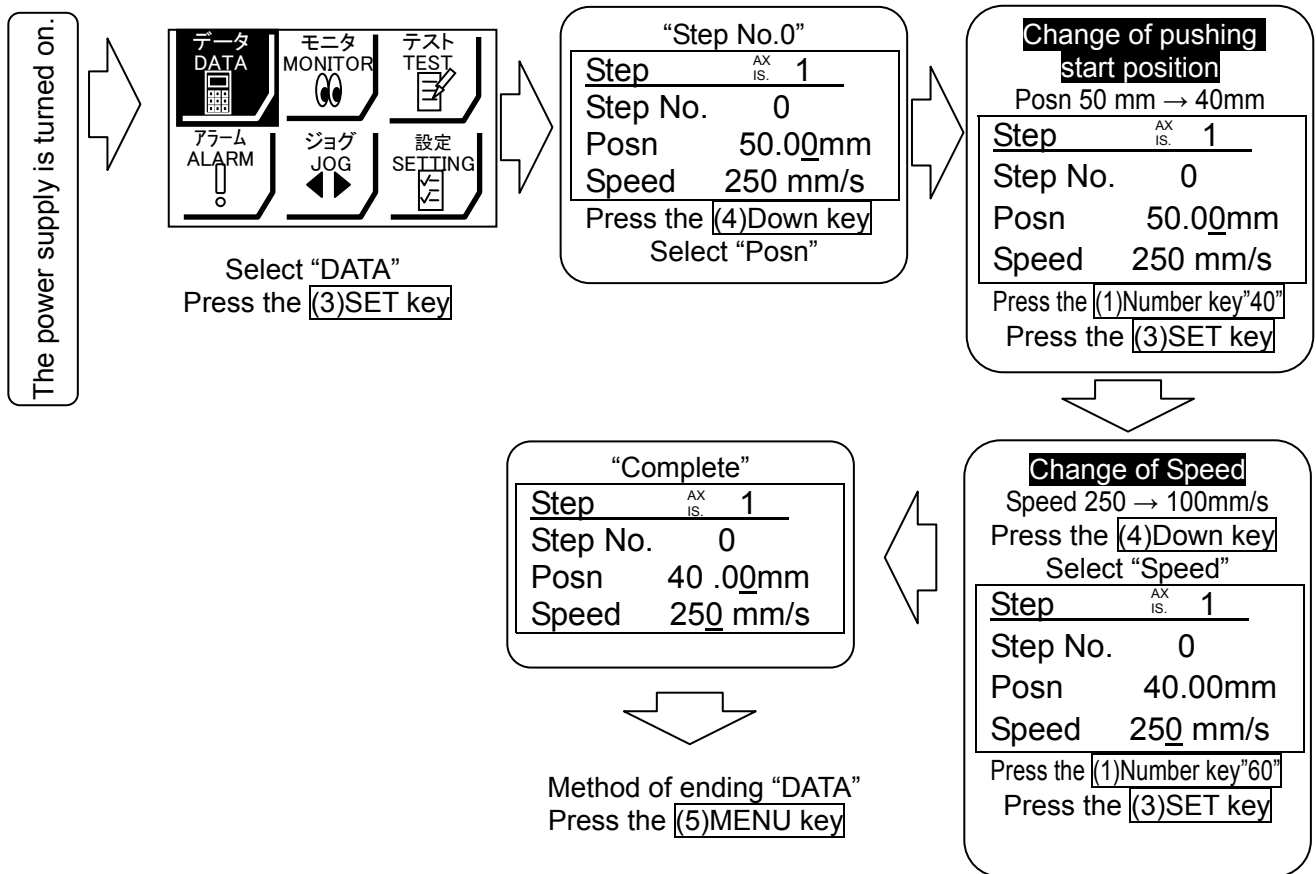

“Step No.1” / Positioning operation / At the time of shipment, Step No.1 is set to positioning operation

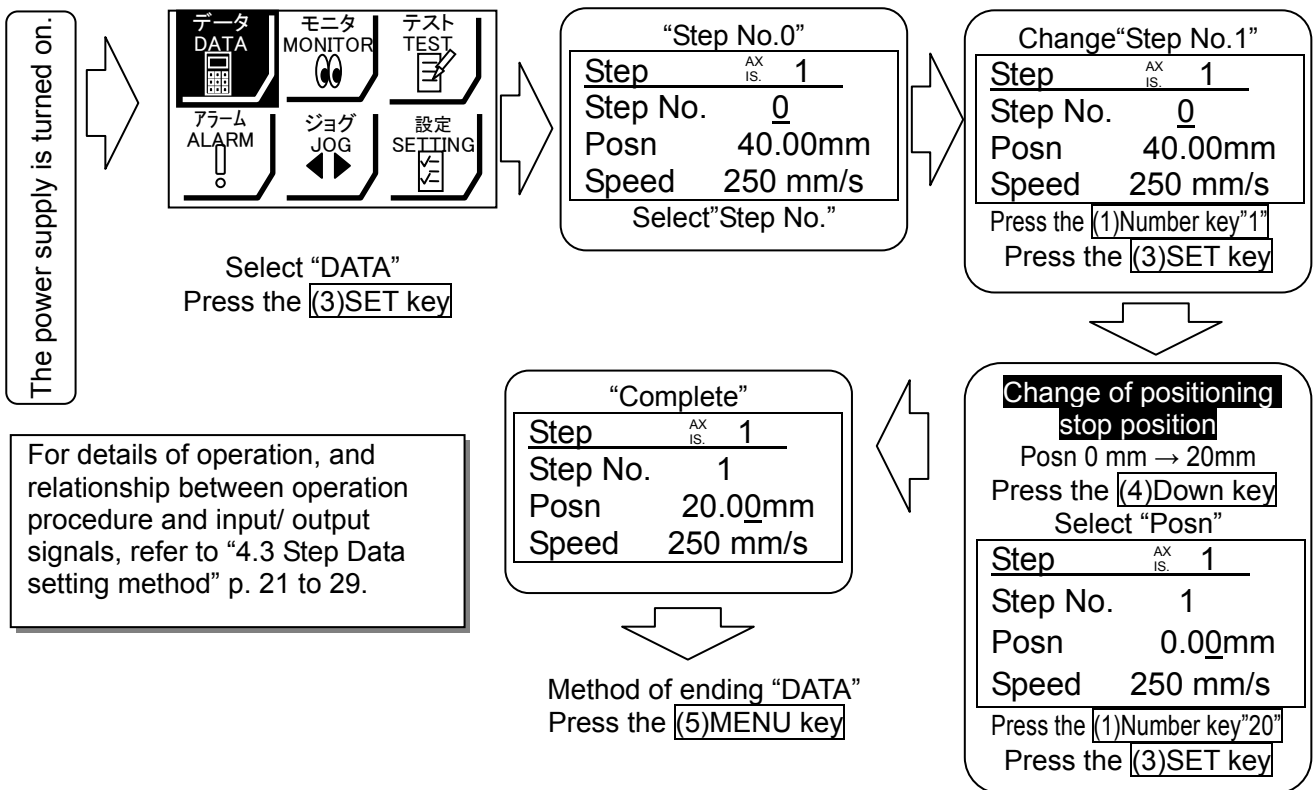

#### 5. Teaching box detailed explanation

Please refer to the teaching box manual.

## 2. Rod type / LEY Series

### 2.1 Specification

#### (1) Step motor (servo 24VDC)

Model		LEY 16				LEY 25				LEY 32				
Actuator specification	Stroke [mm] <sup>Note1)</sup>	30, 50, 100, 150, 200, 250, 300				30, 50, 100, 150, 200, 250, 300, 350, 400				30, 50, 100, 150, 200, 250, 300, 350, 400, 450, 500				
	Work load [kg] <sup>note 2)</sup>	Horizontal	(3000[mm <sup>2</sup> /s])				4, 11, 20, 12, 30, 30				20, 40, 40			
		Vertical	(2000[mm <sup>2</sup> /s])				6, 17, 30, 18, 50, 50				30, 60, 60			
	Pushing force [N] <sup>Notes3)4)</sup>	Vertical	(3000[mm <sup>2</sup> /s])				2, 4, 8, 8, 16, 30				11, 22, 43			
			14 to 38, 27 to 74, 51 to 141				63 to 122, 126 to 238, 232 to 452				80 to 189, 156 to 370, 296 to 707			
	Speed [mm/s]	15 to 500, 8 to 250, 4 to 125				18 to 500, 9 to 250, 5 to 125				24 to 500, 12 to 250, 6 to 125				
	acceleration/deceleration	3,000 or less												
	Pushing speed [mm/s] <sup>Note5)</sup>	50 or less				35 or less				30 or less				
	Positioning repeatability [mm]	+/- 0.02												
	Lead [mm]	10	5	2.5		12	6	3		16	8	4		
	Impact resistance/vibration Resistance [m/s <sup>2</sup> ] <sup>Note6)</sup>	50 / 20												
	Drive method	Ball screw and Belt (For "LEY*_ / R / L ") Ball screw (For "LEY*D")												
	Guide type	Sliding bush (Piston rod part)												
Operating temperature range [°C]	5 to 40													
Operating humidity range [%]	90 RH or less(No condensation)													
Electric specification	Motor size	□28				□42				□56.4				
	Type of Motor	Step motor (Servo 24VDC)												
	Encoder	Incremental A/B phase (800 pulse/rotation)												
	Rated voltage [VDC]	24 +/- 10%												
	Power consumption [W] <sup>Note7)</sup>	23				40				50				
	Standby power consumption when operating [W] <sup>Note8)</sup>	16				15				48				
	Moment max. power Consumption [W] <sup>Note9)</sup>	43				48				104				
Controller weight [kg]	0.15 (Screw mounting type), 0.17(DIN rail mounting type)													
Lock specification	Type <sup>Note10)</sup>	No excitation operating type												
	Holding force [N]	20	39	78		78	157	294		108	216	421		
	Power consumption [W] <sup>Note11)</sup>	3.6				5				5				
	Rated voltage [VDC]	24+/-10%												

Model	LEY 16 [ _ / R / L ]								LEY 25 [ _ / R / L ]								LEY 32 [ _ / R / L ]										
Stroke [mm] <sup>Note1)</sup>	30	50	100	150	200	250	300	30	50	100	150	200	250	300	350	400	30	50	100	150	200	250	300	350	400	450	500
Weight [kg]	0.58	0.62	0.73	0.87	0.98	1.09	1.20	1.18	1.25	1.42	1.68	1.86	2.03	2.21	2.38	2.56	2.09	2.20	2.49	2.77	3.17	3.46	3.74	4.03	4.32	4.60	4.89
Model	LEY 16 D								LEY 25 D								LEY 32 D										
Stroke [mm] <sup>Note1)</sup>	30	50	100	150	200	250	300	30	50	100	150	200	250	300	350	400	30	50	100	150	200	250	300	350	400	450	500
Weight [kg]	0.58	0.62	0.73	0.87	0.98	1.09	1.20	1.17	1.24	1.41	1.67	1.85	2.02	2.20	2.38	2.55	2.08	2.19	2.48	2.76	3.16	3.45	3.73	4.02	4.31	4.59	4.88
Additional weight for lock [kg]	0.12								0.26								0.53										

Note 1) The middle stroke other than the above are produced upon receipt of order.

Note 2) Horizontal: The maximum value of the workload for the positioning operation. For the pushing operation the maximum workload is equal to the "Vertical workload". An external guide is necessary to support the workload. The actual workload and transfer speed will depend on the type of external guide.

Vertical: The speed is dependent on the workload. Check the catalog data for the selected model.

The figures shown in ( ) are the maximum acceleration/deceleration values. Set these values to be 3000mm/s<sup>2</sup> or less.

Note 3) The accuracy of the pushing force is ±20% of the max. pushing force.

Note 4) The setting range for the "Pushing force" is from 35% to 85% (LEY25 is upper bound 65%).

For details of setting range and notes, refer 7.2 "INP output signal" p.41.

It is possible that the "Pushing force" and the "Duty ratio" will change dependent on the set value.

Note 5) "Pushing speed" is the allowable speed for the pushing operation.

Note 6) Impact resistance:

No malfunction occurred when the actuator was tested with a drop tester in both an axial direction and perpendicular direction to the lead screw.

(The test was performed with the actuator in the initial state.)

Vibration resistance:

No malfunction occurred in a test ranging between 45 to 2000 Hz, when the actuator was tested in both an axial direction and a perpendicular direction to the lead screw.

(The test was performed with the actuator in the initial state.)

Note 7) The "Power consumption" (including the controller) is for when the actuator is operating.

Note 8) The "Standby power consumption when operating" (including the controller) is for when the actuator is stopped in the set position during the operation, except during the pushing operation.

Note 9) The "Momentary max. power consumption" (including the controller) is for when the actuator is operating.

This value can be used for the selection of the power supply.

Note 10) With lock only.

Note 11) For an actuator with lock, add the power consumption for the lock.

## (2) Servo motor (24VDC)

Model		LEY 16A			LEY 25A			
Actuator specification	Stroke [mm] <sup>Note1)</sup>	30, 50, 100, 150, 200, 250, 300			30, 50, 100, 150, 200, 250, 300, 350, 400			
	Work load [kg] <sup>note 2)</sup>	Horizontal (3000[mm/s <sup>2</sup> ])	3	6	12	7	15	30
		Vertical (3000[mm/s <sup>2</sup> ])	2	4	8	3	6	12
	Pushing force [N] <sup>Note3)4)</sup>	16to30	30to58	57to111	18to35	37to72	66to130	
	Speed [mm/s]	15 to 500	8 to 250	4 to 125	18 to 500	9 to 250	5 to 125	
	acceleration/deceleration	3,000 or less						
	Pushing speed [mm/s] <sup>Note5)</sup>	50 or less			50 or less			
	Positioning repeatability [mm]	+/- 0.02						
	Lead [mm]	10	5	2.5	12	6	3	
	Impact resistance/vibration Resistance [m/s <sup>2</sup> ] <sup>Note6)</sup>	50 / 20						
	Drive method	Ball screw and Belt (For "LEY*_ / R / L ") Ball screw (For "LEY*D")						
	Guide type	Sliding bush (Piston rod part)						
	Operating temperature range [°C]	5 to 40						
	Operating humidity range [%]	90 RH or less (No condensation)						
Electric specification	Motor size	□28			□42			
	Type of Motor	Servo motor (24VDC)						
	Encoder	Incremental A/B phase (800 pulse/rotation) / Z phase						
	Rated voltage [VDC]	24 +/- 10%						
	Power consumption [W] <sup>Note7)</sup>	40			86			
	Standby power consumption when operating [W] <sup>Note8)</sup>	4 (Horizontal) / 6 (Vertical)			4 (Horizontal) / 12 (Vertical)			
	Moment max. power Consumption [W] <sup>Note9)</sup>	59			96			
	Controller weight [kg]	0.15 (Screw mounting type), 0.17(DIN rail mounting type)						
	Type <sup>Note10)</sup>	No excitation operating type						
	Lock specification	Holding force [N]	20	39	78	78	157	294
Power consumption [W] <sup>Note11)</sup>		3.6			5			
Rated voltage [VDC]		24+/-10%						

Model	LEY 16 [ _ / R / L ] A							LEY 25 [ _ / R / L ] A								
Stroke [mm] <sup>Note1)</sup>	30	50	100	150	200	250	300	30	50	100	150	200	250	300	350	400
Weight [kg]	0.58	0.62	0.73	0.87	0.98	1.09	1.20	1.14	1.21	1.38	1.64	1.82	1.99	2.17	2.34	2.52
Model	LEY 16 D A							LEY 25 D A								
Stroke [mm] <sup>Note1)</sup>	30	50	100	150	200	250	300	30	50	100	150	200	250	300	350	400
Weight [kg]	0.58	0.62	0.73	0.87	0.98	1.09	1.20	1.13	1.20	1.37	1.63	1.81	1.98	2.16	2.33	2.51
Additional weight for lock [kg]	0.12							0.26								

Note 1) The middle stroke other than the above are produced upon receipt of order.

Note 2) Horizontal: The maximum value of the workload for the positioning operation. For the pushing operation the maximum workload is equal to the "Vertical workload". An external guide is necessary to support the workload. The actual workload and transfer speed will depend on the type of external guide.

Vertical: Check the catalog data for the selected model.

The figures shown in ( ) are the maximum acceleration/deceleration values. Set these values to be 3000mm/s<sup>2</sup> or less.

Note 3) The accuracy of the pushing force is ±20% of the max. pushing force.

Note 4) The setting range for the "Pushing force" is from 50% to 95%.

For details of setting range and notes, refer 7.2 "INP output signal" p.41.

It is possible that the "Pushing force" and the "Duty ratio" will change dependent on the set value.

Note 5) "Pushing speed" is the allowable speed for the pushing operation.

Note 6) Impact resistance:

No malfunction occurred when the actuator was tested with a drop tester in both an axial direction and perpendicular direction to the lead screw.

(The test was performed with the actuator in the initial state.)

Vibration resistance:

No malfunction occurred in a test ranging between 45 to 2000 Hz, when the actuator was tested in both an axial direction and a perpendicular direction to the lead screw.

(The test was performed with the actuator in the initial state.)

Note 7) The "Power consumption" (including the controller) is for when the actuator is operating.

Note 8) The "Standby power consumption when operating" (including the controller) is for when the actuator is stopped in the set position during the operation with the maximum workload, except during the pushing operation.

Note 9) The "Momentary max. power consumption" (including the controller) is for when the actuator is operating. This value can be used for the selection of the power supply.

Note 10) With lock only.

Note 11) For an actuator with lock, add the power consumption for the lock.

## 2.2 How to Order

LEY16□□B-50□□□-R16N1□

16
25
32

Motor mounting position	
NIL	Top mounting type
R	Right side parallel type
L	Left side parallel type
D	In-line mounting type

	Motor	Size		
		16	25	32
NIL	Step motor (Servo 24VDC)	●	●	●
A	Servo motor (24VDC)	●	●	-

	LEY16	LEY25	LEY32
A	10	12	16
B	5	6	8
C	2.5	3	4

Stroke [mm]
30
500

\*Refer to the below table for details.

Motor option	
NIL	Without option
C	With motor cover
B	With lock

Rod end thread type	
NIL	Rod end female thread
M	Rod end male thread (1 rod end nut is included)

\*1 When [with lock] specification is selected, [with motor cover] specification cannot be selected.

\*2 When selecting size 16, it is not possible to select strokes shorter than 30.

\* "Stroke" table

	30	50	100	150	200	250	300	350	400	450	500
LEY16	●	●	●	●	●	●	●	-	-	-	-
LEY25	●	●	●	●	●	●	●	●	●	-	-
LEY32	●	●	●	●	●	●	●	●	●	●	●

Controller option	
NIL	Screw mounted
D*	DIN rail mounted

\*Only the controller type "6N" and "6P" correspond.

I/O cable length [m]	
NIL	Without cable
1	1.5
3	3
5	5

Controller type	
NIL	Without controller
6N	With controller (NPN)
6P	With controller (PNP)
1N*	With programless controller (NPN)
1P*	With programless controller (PNP)

\*Only "Step motor" can be selected.

Actuator cable length [m]			
NIL	Without cable	8*	8
1	1.5	A*	10
3	3	B*	15
5	5	C*	20

\*Produced upon receipt of order. (Only "Robotic type cable" can be selected.)

Actuator cable type	
NIL	Without cable
R	Robotic type cable
S*	Standard cable

\*Only "Step motor" can be selected.

Mounting style			
NIL	Both ends tapped style (Standard)	F	Rod side flange style
U	Body bottom tapped style	G	Motor side flange style
L	Foot style	D	Double clevis style

\*When [Motor: In-line mounting type] specification is selected, [Foot style], [Motor side flange style], and [Double clevis style] specification cannot be selected.

\*Mounting bracket is included, (but not assembled).

\*When mounting styles are [Rod flange], [Head flange] or [Ends tapped] with one end fixed and mounted in a horizontal direction, use it within the following stroke.

●LEY25: 200 or less ●LEY32: 100 or less

\*In case of [Double clevis], use the actuator within the following stroke limit.

●LEY16: 100 or less ●LEY25: 200 or less ●LEY32: 200 or less

\*[Motor side flange style] for LEY32 is not available.

## ⚠ Caution

**The actuator body and controller are sold as a package.**

If when only the actuator is purchased separately, confirm that the combination of the controller, which you have and the actuator is compatible. / See 6.3 ⚠ Caution(1) on p.38

<Be sure to check the following before use.>

- (1) Check that actuator label for model number. This matches the controller.
- (2) Check Parallel I/O configuration matches (NPN or PNP).

(1)  
LEY16B-100  
NPN



(2)

## 2.3 Construction

**Top mounting type**  
(Right / Left side parallel type)

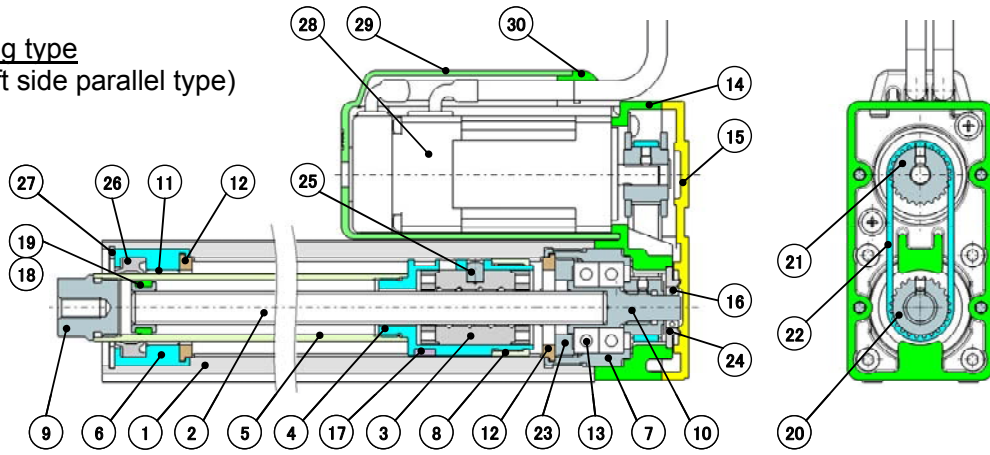

**In-line mounting type**

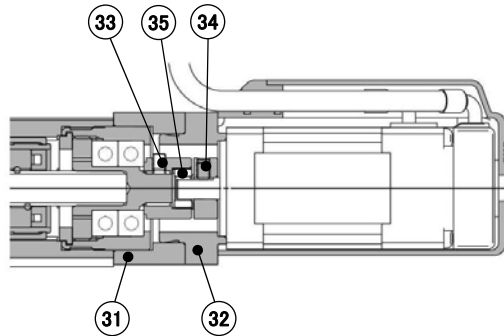

### Parts list

No.	Part	Material	Remarks
1	Body	Aluminum alloy	Anodized
2	Ball screw shaft	High carbon chrome bearing steel	
3	Ball screw nut	-	
4	Piston	Aluminum alloy	
5	Piston rod	Stainless steel	Hard chrome anodized
6	Rod cover	Aluminum alloy	
7	houjing	Aluminum alloy	
8	Rotation stopper	Plastic	
9	Socket	Free cutting carbon steels	Nickel plated
10	Connected shaft	Free cutting carbon steels	Nickel plated
11	Bushing	Lead bronze cast	
12	Bumper	Urethane	
13	Bearing	-	
14	Pully box	Aluminum die-cast	Non-Hexavalent chromated
15	Pully plate	Aluminum die-cast	Non-Hexavalent chromated
16	Bearing	-	
17	Magnet	-	
18	Wear ring holder	Stainless steel	Only stroke 101mm or more
19	Wear ring	POM	Only stroke 101mm or more
20	Pulley (For Screw shaft)	Aluminum alloy	

No.	Part	Material	Remarks
21	Pulley (For motor)	Aluminum alloy	
22	Belt	-	
23	Bearing stopper	Aluminum alloy	
24	Bearing support	Stainless steel	
25	Parallel pin	Stainless steel	
26	Rod seal	NBR	
27	Retaining ring	Steel for spring	
28	Motor	-	
29	Motor cover	Plastic	Only "With motor cover"
30	Grommet	Plastic	Only "With motor cover"
31	Motor block	Aluminum alloy	Anodized
32	Motor adapter	Aluminum alloy	Anodized
33	Hub	Aluminum alloy	
34	Hub	Aluminum alloy	
35	sleeve	NBR	

### Mounting bracket part number

Size	Foot	Flange	Double clevis
16	LEY-L016	LEY-F016	LEY-D016
25	LEY-L025	LEY-F025	LEY-D025
32	LEY-L032	LEY-F032	LEY-D032

/ When ordering foot bracket, order 2 pieces per actuator.

/ Parts belonging to each bracket are as follows.

Foot, Flange: Body mounting bolt.

Double clevis: Clevis pin, Type C retaining ring for axis, Body mounting bolt.

### Maintenance parts / belt

Size	Part number
16	LE-D-2-1
25	LE-D-2-2
32	LE-D-2-3

/ See 7.4 Precaution on maintenance on p.46

/ See 7.5 Replacement of belt on p.47

### 3. Guide rod type / LEYG Series

#### 3.1 Specification

##### (1) Step motor (servo 24VDC)

Model		LEYG 16 <sup>M</sup> <sub>L</sub>			LEYG 25 <sup>M</sup> <sub>L</sub>			LEYG 32 <sup>M</sup> <sub>L</sub>				
Actuator specification	Stroke [mm] <sup>Note1)</sup>	30, 50, 100, 150, 200			30, 50, 100, 150, 200, 250, 300			30, 50, 100, 150, 200, 250, 300				
	Work load [kg] <sup>note 2)</sup>	Horizontal	(3000[mm <sup>2</sup> /s])	4	11	20	12	30	30	20	40	40
			(2000[mm <sup>2</sup> /s])	6	17	30	18	50	50	30	60	60
	Vertical	(3000[mm <sup>2</sup> /s])	1.5	3.5	7.5	7	15	29	9	20	41	
		Pushing force [N] <sup>Note3)4)</sup>	14 to 38	27 to 74	51 to 141	63 to 122	126 to 238	232 to 452	80 to 189	156 to 370	296 to 707	
	Speed [mm/s]	15 to 500	8 to 250	4 to 125	18 to 500	9 to 250	5 to 125	24 to 500	12 to 250	6 to 125		
	acceleration/deceleration	3,000 or less										
	Pushing speed [mm/s] <sup>Note5)</sup>	50 or less			50 or less			50 or less				
	Positioning repeatability [mm]	+/- 0.02										
	Lead [mm]	10	5	2.5	12	6	3	16	8	4		
	Impact resistance/vibration Resistance [m/s <sup>2</sup> ] <sup>Note6)</sup>	50 / 20										
	Drive method	Ball screw and Belt										
	Guide type	Slide bearing (LEYG□M), Ball bushing bearing (LEYG□L)										
	Operating temperature range [°C]	5 to 40										
Operating humidity range [%]	90 RH or less (No condensation)											
Electric specification	Motor size	□28			□42			□56.4				
	Type of Motor	Step motor (Servo 24VDC)										
	Encoder	Incremental A/B phase (800 pulse/rotation)										
	Rated voltage [VDC]	24 +/- 10%										
	Power consumption [W] <sup>Note7)</sup>	23			40			50				
	Standby power consumption when operating [W] <sup>Note8)</sup>	16			15			48				
	Moment max. power Consumption [W] <sup>Note9)</sup>	43			48			104				
Controller weight [kg]	0.15 (Screw mounting type), 0.17(DIN rail mounting type)											
Lock specification	Type <sup>Note10)</sup>	No excitation operating type										
	Holding force [N]	20	39	78	78	157	294	108	216	421		
	Power consumption [W] <sup>Note11)</sup>	3.6			5			5				
Rated voltage [VDC]	24+/-10%											

Model	LEYG 16M					LEYG 25M					LEYG 32M								
Stroke [mm]	30	50	100	150	200	30	50	100	150	200	250	300	30	50	100	150	200	250	300
Weight [kg]	0.83	0.97	1.20	1.49	1.66	1.67	1.86	2.18	2.60	2.94	3.28	3.54	2.91	3.17	3.72	4.28	4.95	5.44	5.88
Model	LEYG 16L					LEYG 25L					LEYG 32L								
Stroke [mm]	30	50	100	150	200	30	50	100	150	200	250	300	30	50	100	150	200	250	300
Weight [kg]	0.84	0.97	1.14	1.43	1.58	1.68	1.89	2.13	2.56	2.82	3.14	3.38	2.91	3.18	3.57	4.12	4.46	5.17	5.56
Additional weight for lock [kg]	0.12					0.26					0.53								

Note 1) The middle stroke other than the above are produced upon receipt of order.

Note 2) Horizontal: The maximum value of the workload for the positioning operation. For the pushing operation the maximum workload is equal to the "Vertical workload". An external guide is necessary to support the workload. The actual workload and transfer speed will depend on the type of external guide.

Vertical: The speed is dependent on the workload. Check the catalog data for the selected model.

The figures shown in ( ) are the maximum acceleration/deceleration values. Set these values to be 3000mm/s<sup>2</sup> or less.

Note 3) The accuracy of the pushing force is ±20% of the max. pushing force.

Note 4) The setting range for the "Pushing force" is from 35% to 85% (LEYG25 is upper bound 65%).

For details of setting range and notes, refer 7.2 "INP output signal" p.41.

It is possible that the "Pushing force" and the "Duty ratio" will change dependent on the set value.

Note 5) "Pushing speed" is the allowable speed for the pushing operation.

Note 6) Impact resistance:

No malfunction occurred when the actuator was tested with a drop tester in both an axial direction and perpendicular direction to the lead screw.

(The test was performed with the actuator in the initial state.)

Vibration resistance:

No malfunction occurred in a test ranging between 45 to 2000 Hz, when the actuator was tested in both an axial direction and a perpendicular direction to the lead screw.

(The test was performed with the actuator in the initial state.)

Note 7) The "Power consumption" (including the controller) is for when the actuator is operating.

Note 8) The "Standby power consumption when operating" (including the controller) is for when the actuator is stopped in the set position during the operation, except during the pushing operation.

Note 9) The "Momentary max. power consumption" (including the controller) is for when the actuator is operating.

This value can be used for the selection of the power supply.

Note 10) With lock only.

Note 11) For an actuator with lock, add the power consumption for the lock.



## (2) Servo motor (24VDC)

Model		LEYG 16 <sup>M</sup> <sub>L</sub> A			LEYG 25 <sup>M</sup> <sub>L</sub> A			
Actuator specification	Stroke [mm] <sup>Note1)</sup>	30, 50, 100, 150, 200			30, 50, 100, 150, 200, 250, 300			
	Work load [kg] <sup>note 2)</sup>	Horizontal (3000[mm/s <sup>2</sup> ])	3	6	12	7	15	30
		Vertical (3000[mm/s <sup>2</sup> ])	1.5	3.5	7.5	2	5	11
	Pushing force [N] <sup>Note3)4)</sup>	16to30	30to58	57to111	18to35	37to72	66to130	
	Speed [mm/s]	15 to 500	8 to 250	4 to 125	18 to 500	9 to 250	5 to 125	
	acceleration/deceleration	3,000 or less						
	Pushing speed [mm/s] <sup>Note5)</sup>	50 or less			50 or less			
	Positioning repeatability [mm]	+/- 0.02						
	Lead [mm]	10	5	2.5	12	6	3	
	Impact resistance/vibration Resistance [m/s <sup>2</sup> ] <sup>Note6)</sup>	50 / 20						
	Drive method	Ball screw and Belt						
	Guide type	Slide bearing (LEYG□M), Ball bushing bearing (LEYG□L)						
	Operating temperature range [°C]	5 to 40						
	Operating humidity range [%]	90 RH or less (No condensation)						
Electric specification	Motor size	□28			□42			
	Type of Motor	Servo motor (24VDC)						
	Encoder	Incremental A/B phase (800 pulse/rotation) /Z phase						
	Rated voltage [VDC]	24 +/- 10%						
	Power consumption [W] <sup>Note7)</sup>	40			86			
	Standby power consumption when operating [W] <sup>Note8)</sup>	4 (Horizontal) / 6 (Vertical)			4 (Horizontal) / 12 (Vertical)			
	Moment max. power Consumption [W] <sup>Note9)</sup>	59			96			
	Controller weight [kg]	0.15 (Screw mounting type), 0.17(DIN rail mounting type)						
Lock specification	Type <sup>Note10)</sup>	No excitation operating type						
	Holding force [N]	20	39	78	78	157	294	
	Power consumption [W] <sup>Note11)</sup>	3.6			5			
	Rated voltage [VDC]	24+/-10%						

Model	LEYG 16MA					LEYG 25MA						
Stroke [mm]	30	50	100	150	200	30	50	100	150	200	250	300
Weight [kg]	0.83	0.97	1.20	1.49	1.66	1.63	1.82	2.14	2.56	2.90	3.24	3.50
Model	LEYG 16LA					LEYG 25LA						
Stroke [mm]	30	50	100	150	200	30	50	100	150	200	250	300
Weight [kg]	0.84	0.97	1.14	1.43	1.58	1.64	1.85	2.09	2.52	2.78	3.10	3.34
Additional weight for lock [kg]	0.12					0.19						

Note 1) The middle stroke other than the above are produced upon receipt of order.

Note 2) Horizontal: The maximum value of the workload for the positioning operation. For the pushing operation the maximum workload is equal to the "Vertical workload". An external guide is necessary to support the workload. The actual workload and transfer speed will depend on the type of external guide.

Vertical: Check the catalog data for the selected model.

The figures shown in ( ) are the maximum acceleration/deceleration values. Set these values to be 3000mm/s<sup>2</sup> or less.

Note 3) The accuracy of the pushing force is ±20% of the max. pushing force.

Note 4) The setting range for the "Pushing force" is from 50% to 95%.

For details of setting range and notes, refer 7.2 "INP output signal" p.41.

It is possible that the "Pushing force" and the "Duty ratio" will change dependent on the set value.

Note 5) "Pushing speed" is the allowable speed for the pushing operation.

Note 6) Impact resistance:

No malfunction occurred when the actuator was tested with a drop tester in both an axial direction and perpendicular direction to the lead screw.

(The test was performed with the actuator in the initial state.)

Vibration resistance:

No malfunction occurred in a test ranging between 45 to 2000 Hz, when the actuator was tested in both an axial direction and a perpendicular direction to the lead screw.

(The test was performed with the actuator in the initial state.)

Note 7) The "Power consumption" (including the controller) is for when the actuator is operating.

Note 8) The "Standby power consumption when operating" (including the controller) is for when the actuator is stopped in the set position during the operation with the maximum workload, except during the pushing operation.

Note 9) The "Momentary max. power consumption" (including the controller) is for when the actuator is operating.

This value can be used for the selection of the power supply.

Note 10) With lock only.

Note 11) For an actuator with lock, add the power consumption for the lock.



### 3.2 How to Order

**LEYG 16 M □ □ B - 50 □ □ - R 1 6N 1 □**

**Size**

16
25
32

**Bearing type**

M	Slide bearing
L	Ball bushing bearing

**Motor mounting position**

Nil	Top mounting type
D	In-line mounting type

**Motor type**

Symbol	Type	Size			Controller type
		16	25	32	
Nil	Step motor (Servo 24VDC)	●	●	●	6N, 6P 1N, 1P
A	Servo motor (24VDC)	●	●	-	6N, 6P

**Lead [mm]**

Symbol	LEYG16	LEYG25	LEYG32
A	10	12	16
B	5	6	8
C	2.5	3	4

**Motor option**

Nil	None
C	With motor cover
B	With lock

\*1 When [with lock] specification is selected, [with motor cover] specification cannot be selected.  
\*2 When selecting size 16, it is not possible to select strokes shorter than 30.

**Stroke [mm]**

30
5
300

\*Refer to "Stroke" table

**Guide option**

Nil	None
F	With Grease maintenance mechanism

\*When selecting "Slide bearing" of size 25 and 32, it is possible to be selected.

**Controller mounting**

Nil	Screw mounting type
D*	DIN rail mounting type

\*Only the controller type "6N" and "6P" correspond.

**I/O cable length [m]**

Nil	Without cable
1	1.5
3	3
5	5

**Controller type**

Nil	Without controller
6N	With controller (NPN)
6P	With controller (PNP)
1N*	With programless controller (NPN)
1P*	With programless controller (PNP)

\*Only "Step motor" can be selected.

**Actuator cable length [m]**

Nil	Without cable	8*	8
1	1.5	A*	10
3	3	B*	15
5	5	C*	20

\*Produced upon receipt of order. (Only "Robotic type cable" can be selected.)

**Actuator cable type**

Nil	Without cable
R	Robotic type cable
S*	Standard cable

\*Only "Step motor" can be selected.

\* "Stroke" table

Model \ Stroke	30	50	100	150	200	250	300
LEYG16	●	●	●	●	●	●	●
LEYG25	●	●	●	●	●	●	●
LEYG32	●	●	●	●	●	●	●

## ⚠ Caution

### The actuator body and controller are sold as a package.

If when only the actuator is purchased separately, confirm that the combination of the controller, which you have and the actuator is compatible. / See 6.3 ⚠ Caution(1) on p.38

<Be sure to check the following before use.>

- (1) Check that actuator label for model number. This matches the controller.
- (2) Check Parallel I/O configuration matches (NPN or PNP).

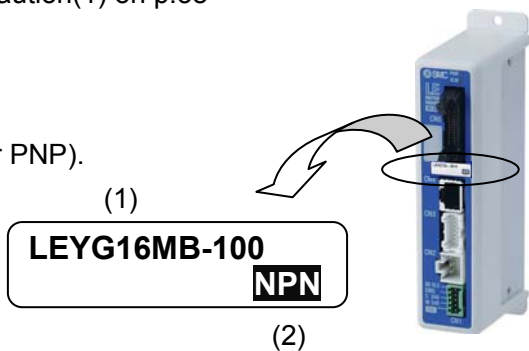

### 3.3 Construction

Motor mounting position:  
Top mounting type

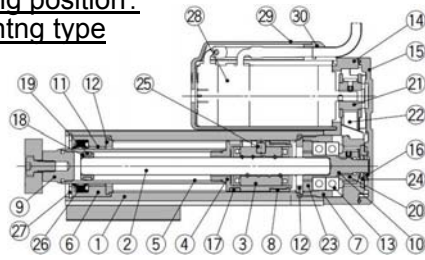

LEYG□M

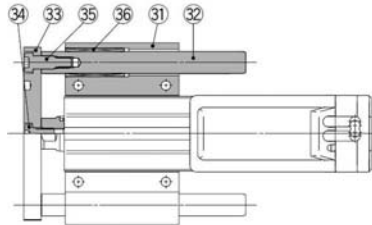

LEYG□L

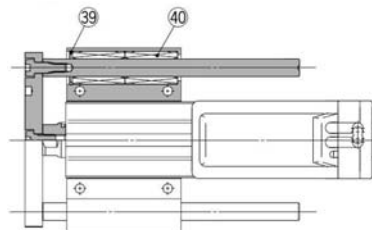

Motor mounting position:  
In-line mounting type

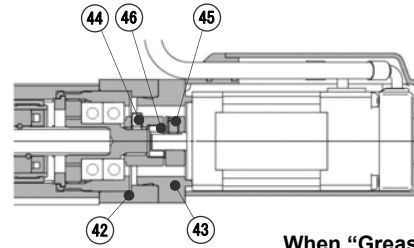

When "Grease maintenance mechanism" is selected

LEYG25/3 M: 50 stroke or less

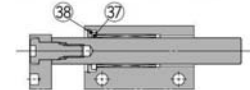

LEYG25/32M: Over 50 stroke



LEYG\*M: 50 stroke or less

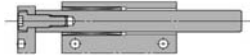

LEYG\*M: Over 50 stroke



LEYG16L: 30 stroke or less  
LEYG25/32L 100 stroke or less

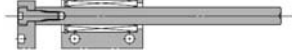

LEYG16L: Over 30 stroke



LEYG\*L: Over 100 stroke

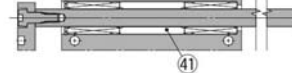

No.	Part	Material	Remarks	No.	Part	Material	Remarks
1	Body	Aluminum alloy	Anodized	24	Bearing support	Stainless steel	
2	Ball screw shaft	High carbon chrome bearing steel		25	Parallel pin	Stainless steel	
3	Ball screw nut	-		26	Rod seal	NBR	
4	Piston	Aluminum alloy		27	Retaining ring	Carbon tool steel	Phosphate coated
5	Piston rod	Stainless steel	Hard chrome anodized	28	Motor	-	
6	Rod cover	Aluminum alloy		29	Motor cover	Plastic	Only "With motor cover"
7	Houjing	Aluminum alloy		30	Grommet	Plastic	Only "With motor cover"
8	Rotation stopper	Plastic		31	Guide attachment	Aluminium alloy	Anodized
9	Socket	Free cutting carbon steels	Nickel plated	32	Guide rod	Carbon steel	Hard chrome plated
10	Connected shaft	Free cutting carbon steels	Nickel plated	33	Plate	Aluminium alloy	Anodized
11	Bushing	Lead bronze cast		34	Plate mounting bolt	Carbon tool steel	Nickel plated
12	Bumper	Urethane		35	Guide bolt	Carbon tool steel	Nickel plated
13	Bearing	-		36	Slide Bearing	Babbitt	
14	Pully box	Aluminum die-cast	Non-Hexavalent chromated	37	Felt	Felt	
15	Pully plate	Aluminum die-cast	Non-Hexavalent chromated	38	Holder	Resin	
16	Bearing	-		39	Retaining ring	Carbon tool steel	Phosphate coated
17	Magnet	-		40	Ball bushing		
18	Wear ring holder	Stainless steel	Only stroke 101mm or more	41	Spacer	Aluminium alloy	
19	Wear ring	POM	Only stroke 101mm or more	42	Motor brock	Aluminium alloy	Anodized
20	Pulley (For Screw shaft)	Aluminum alloy		43	Motor adapter	Aluminium alloy	Anodized
21	Pulley (For motor)	Aluminum alloy		44	Hub	Aluminium alloy	
22	Belt	-		45	Hub	Aluminium alloy	
23	Bearing stopper	Aluminium alloy		46	sleeve	NBR	

#### Support block

Size	Part number
16	LEYG-S016
25	LEYG-S025
32	LEYG-S032

\*Mounting bolt (2 pieces) is included in Support block.

#### Maintenance parts / belt

Size	Part number
16	LE-D-2-1
25	LE-D-2-2
32	LE-D-2-3

/ See 7.4 Precaution on maintenance on p.46  
/ See 7.5 Replacement of belt on p.47

## 4. Product Outline

### 4.1 System construction

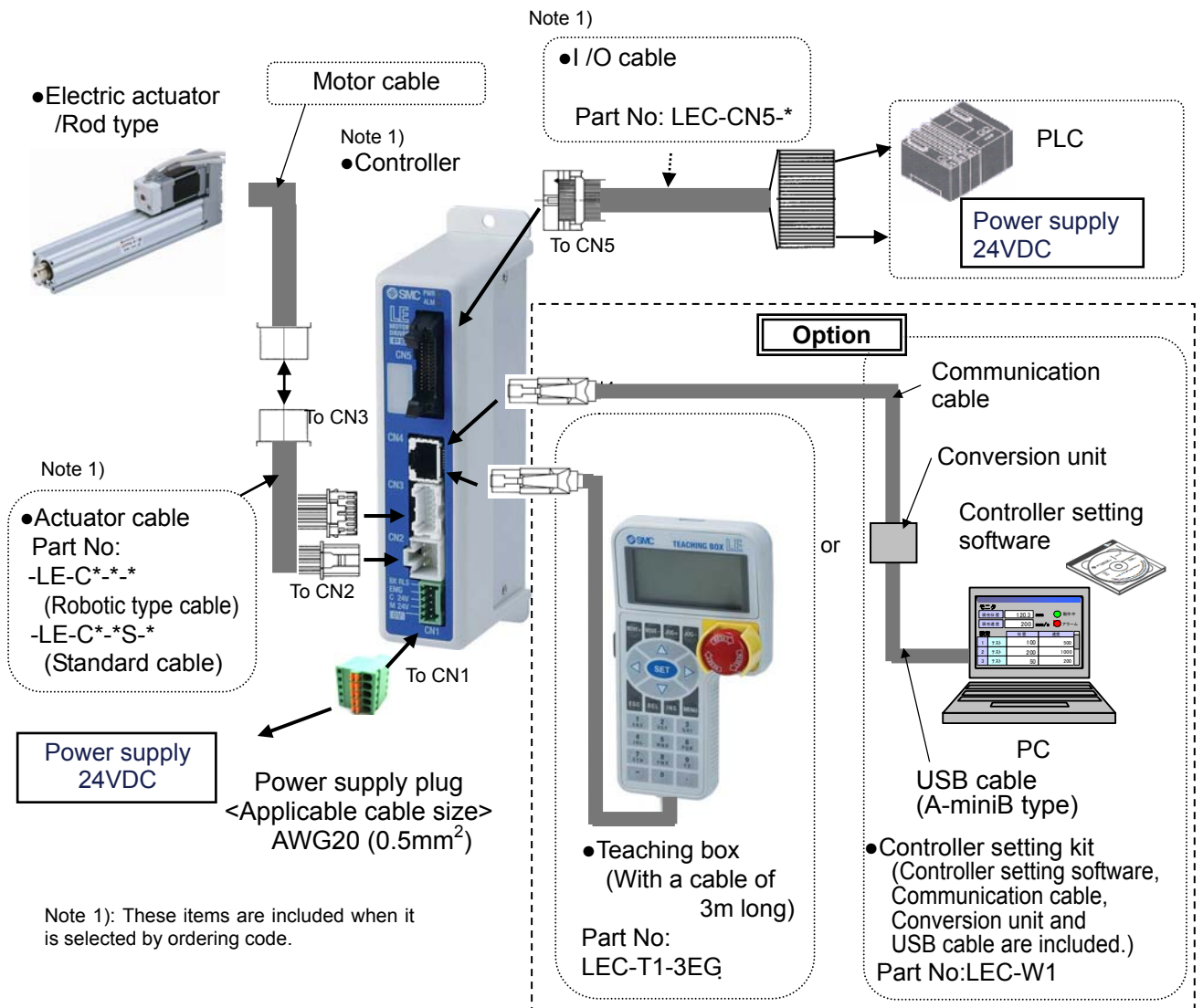

Note 1): These items are included when it is selected by ordering code.

## Warning

Refer to the operation manual of the LEC (controller) for detailed wiring.

/ See 5 Wiring of cables on p.35 .

Communication cable is to be connected to PC by USB cable through conversion unit.

Do not connect the teaching box directly to the PC.

Use only specified cables otherwise there maybe fire risk and damage.

The actuator body and controller are sold as a package.

If when only the actuator is purchased separately, confirm that the combination of the controller, which you have and the actuator is compatible.

/ See 6.3 Caution (1) on p. 38

<Be sure to check the following before use.>

(1) Check that actuator label for model number.

This matches the controller.

(2) Check Parallel I/O configuration matches (NPN or PNP).

(1)  
LEY16B-100

NPN

(2)



## 4.2 Setting Function

Refer to the operation manual of the controller (LEC series) for the detail of the setting function.

### Easy Mode for simple setting

>Select “Easy mode” for instant operation

### Controller setting software

- Setting and operation, such as the step data setting, test drive and JOG / fixed-distance moving, can be performed on the same page.

Speed setting of JOG / fixed distance

JOG moving

Start testing

Positioning data setting

Fixed distance moving

### Teaching box

- Setting and operation by the simple screen without scrolling.
- Select function by the iconized menu at the first page.
- Step data setting and monitoring at the second page.

1st screen

2nd screen

Data	Axis 1
Step No.	0
Posn	123.45mm
speed	400mm/s

It can be registered by “SET” after entering the values.

**Example of setting the step data**

1st screen

2nd screen

Monitor	Axis 1
Step No.	1
Posn	12.34mm
speed	50mm/s

Operation status can be checked

**Example of checking the operation status**

## Normal mode for the detailed setting

➤ Select “Normal mode” if the detailed setting are necessary.

- Step data can be set in detail.
- Parameters can be set.
- Signals and terminal condition can be monitored.
- JOG and fixed distance movement, return to origin position, test operation and testing of compulsory output can be done.

## Controller setting soft ware

➤ Every function, step data, parameter, monitor and teaching are indicated in a different window.

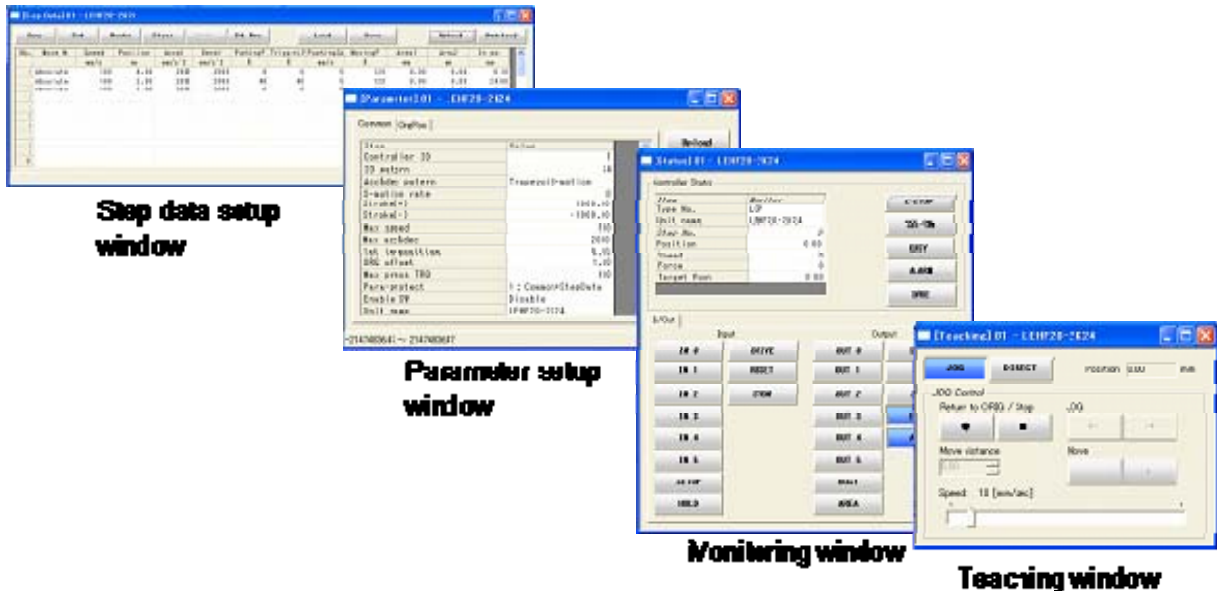

## Teaching box

- The data in the controller can be saved / forwarded in this teaching box.
- Continuous test operation can be made after specifying five step data.

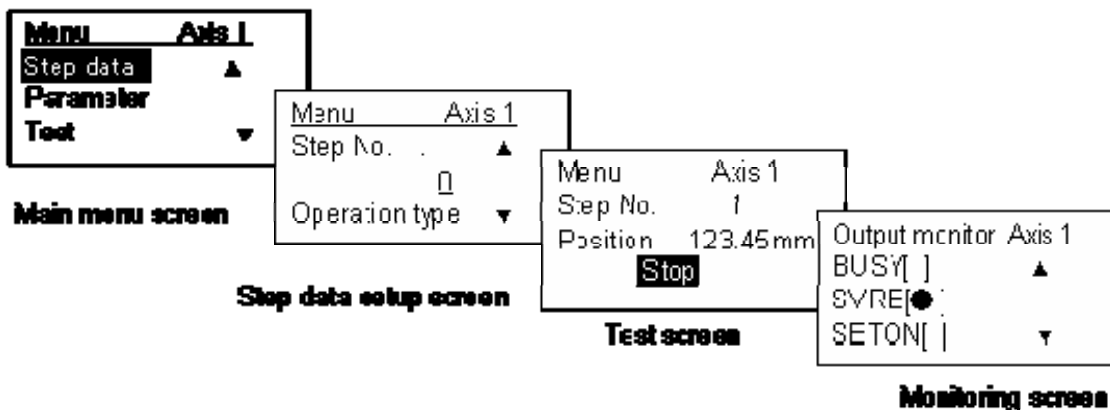

## Controlled items

PC: Controller setting software    TB: Teaching box  
 ○: Available function    ×: Not available function

Function		Content	Easy mode		Normal mode
			PC	TB	PC/TB
Step data (Except)	Movement method	Can be selected of absolute / relative position move	○	×	○
	Speed	Can be set in units of 1mm/s.	○	○	○
	Position	Can be set in units of 0.01mm.	○	○	○
	Acceleration Deceleration	Can be set in units of 1mm/s <sup>2</sup> .	○	○	○
	Pushing force	Can be set in units of 1%. / In case of positioning operation: Set to 0%.	○	○	○
	Trigger LV	Trigger LV of target pushing force when pushing operation: Can be set in units of 1%.	○	×	○
	Pushing speed	Can be set in units of 1mm/s.	○	×	○
	Moving force	100% (Not changeable).	○	×	○
	Area output	Can be set in units of 0.01mm.	○	×	○
	In position	During positioning operation: Width to the target position. It should be set to 0.5 or more. During pushing operation: How much it moves during pushing.	○	×	○
Parameter (Excerpt)	Stroke(+)	+ side limit of position. (Can be set in units of 0.01mm)	×	×	○
	Stroke(-)	- side limit of position. (Can be set in units of 0.01mm).	×	×	○
	ORIG direction	Direction of the return to the original position can be set	×	×	○
	ORIG speed	Speed when returning to the original position can be set.	×	×	○
	ORIG ACC	Acceleration when returning to origin can be set.	×	×	○
Test	JOG	It can make continuous operation at the set speed while the switch is being pressed	○	○	○
	MOVE	It can make test operation at the set distance and speed from the current position when the switch is pressed.	○	×	○
	Return to ORIG	Test of return to origin can be done.	○	○	○
	Test drive	The operation of the specified step data can be tested.	○	○	○ (Continuous operation)
	Force output	ON/OFF of the output terminal can be tested.	×	×	○
Monitor	DRV mon	Current position, current speed, current force and the specified step data No. can be monitored.	○	○	○
	In/Out mon	Current ON/OFF status of the input and output terminal can be monitored.	×	×	○
ALM	Status	The alarm currently being generated can be confirmed, and be reset.	○	○	○
	ALM Log record	The alarm generated in the past can be confirmed.	×	×	○
File	Save - Load	The step data and parameter of the objective controller can be saved, forwarded and deleted.	×	×	○
Other	Language	Language can be changed to Japanese / English.	○ *3	○ *2	○ *2 *3

\*1 Every parameter is set to the recommended condition before shipment from the factory. Only change the setting of the items which require adjustment.

\*2 Teaching box: In the Normal mode the teaching box can be set to work in English or Japanese.

\*3 Controller setting software: Can be installed by selecting English version or Japanese version.

### 4.3 Step data setting method

Refer to the operation manual of the controller (LEC series) for details.

This operation manual specifies the electric actuator, if an actuator other than the electric actuator is used, refer to the operation manual of each type of actuator and controller (LEC series) regarding the description of step data.

#### **Caution**

**The actuator body and controller are sold as a package.**

If when only the actuator is purchased separately, confirm that the combination of the controller, which you have and the actuator is compatible. / See 6.3  Caution(1) on P.38.

<Be sure to check the following before use.>

- (1) Check that actuator label for model number.  
This matches the controller.
- (2) Check Parallel I/O configuration matches (NPN or PNP).

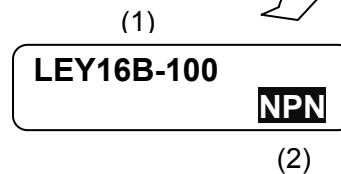

### Positioning operation

In the positioning operation, the electric actuator transfers to and stops at the target position. The following image shows the set items and operation.

#### <Confirmation of reaching the target position during the positioning operation>

When the electric actuator reaches the range of the target position, the target position reaching signal **【INP】** (in position) is outputted.

When the rod of actuator enters the range of **【in position】**, the INP output signal turns on.

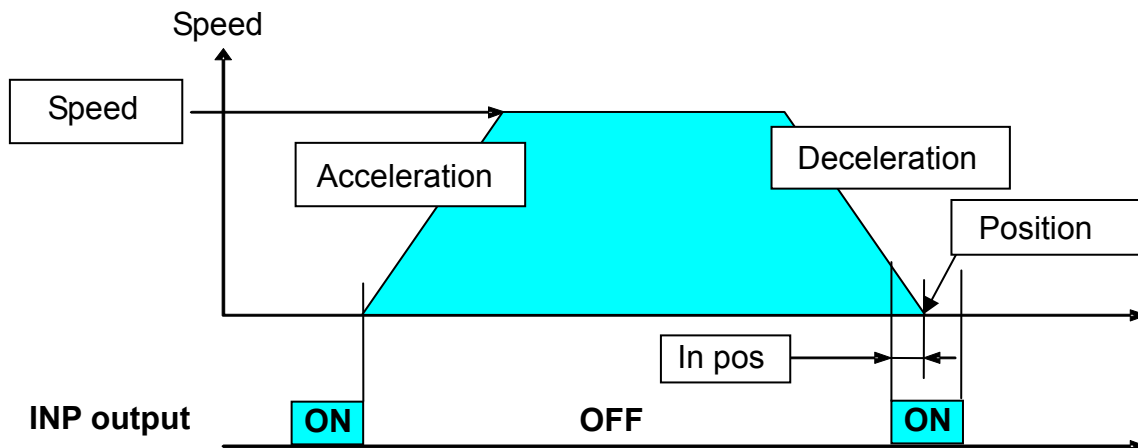

#### **Caution**

**Please use it by "Pushing operation" when you make it hold.**

The product may be damaged by the impact when using it in "Positioning operation".

/ See 7.2  Caution(2) on p.41



## <Items and set values in positioning operation>

### Step No. 1: Positioning operation

	a	b	c	d	e	f	g	h	i	j		k
No.	Move M	Speed	Position	Accel	Decel	PushingF	TriggerLV	PushingSp	MovingF	Area1	Area2	In pos
		mm/s	mm	mm/s <sup>2</sup>	mm/s <sup>2</sup>	%	%	mm/s	%	mm	mm	mm
0	Absolute	250	50.00	3000	3000	60	40	30	100	48.00	50.00	20.00
1	Absolute	250	0.00	3000	3000	0	0	1	100	0.00	2.00	0.50

[  ] Need to be set - [  ] Need to be adjusted as required.

[ × ] Not used. Items don't need to be changed in positioning operation.

**a** <  Movement MOD > When the absolute position is required, set Absolute  
When the relative position is required, set Relative  
→ Absolute: Distance from the origin position. / General setting method.  
Relative: Feed from the current position. / This is used when simplified data.

**b** <  Speed > Transfer speed to the target position.

**c** <  Position > Target position.

**d** <  Acceleration > The parameter which defines how rapidly the actuator reaches the speed set in **b**.  
The higher the set value, the faster it reaches the speed set in **b**.

**e** <  Deceleration > The parameter which defines how rapidly the actuator comes to stop.  
The higher the set value, the quicker it stops.

**f** <  Pushing force > Set **0**.  
(If values other than 0 set the operation will be changed to the pushing operation.)

**g** < × Trigger LV > For pushing operation only.

**h** < × Pushing speed > For pushing operation only.

**i** <  Moving force > Max. Force at the positioning operation.  
The force is automatically adjusted corresponding to the load.  
/See 7.2 Caution(4) on p.42

**j** <  Area1, Area2 > This is the condition that turns on the AREA output signal.  
The setting condition should be **Area 1 < Area 2**.  
It is possible to set at relative operation.  
The position will be Absolute (position from the origin).

Example) In case of Step no.1

[AREA] output signal is outputted between Area 1:0 and Area 2:2.

**k** <  In position > This is the condition that turns on the INP (in position) output signal.  
→When the electric actuator reaches the range of the target position, the INP output signal is output.  
When the electric actuator enters the range of [in position], the INP output signal turns on.  
When it is necessary to output the target position reaching signal earlier, make the value larger.  
Note) Set the value more than [0.50].

Example) In case of Step no.1

Position: 0 + In position: 0.5 = [INP] is outputted from the value of 0.5.

## Pushing operation

The rod move to the target position and hold a work piece with the set pushing force. The figure shows setting items and operation. The setting items and values are described below.

### <Confirmation of reaching the target value during the pushing operation>

The "target position reaching signal" INP (in position) is generated when the target pushing force (Trigger LV) is achieved.

Also, if the actual pushing force exceeds the Trigger LV, the INP signal is turned on.

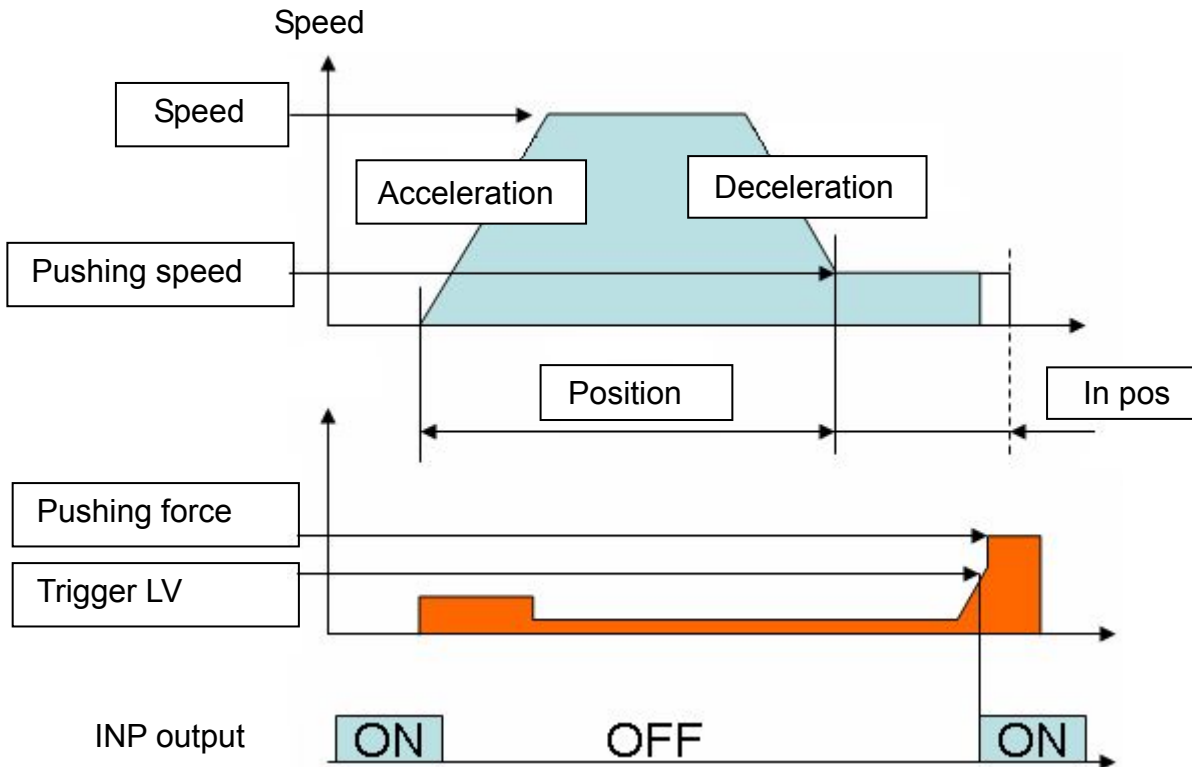

### **Caution**

**Please use it by "Pushing operation" when you make it hold.**

The product may be damaged by the impact when using it in "Positioning operation".

/ See 7.2  Caution(2) on p.41

## <Items and setting values of pushing operation>

### Step no. 0: Pushing operation

	a	b	c	d	e	f	g	h	i	j	k	
No.	Move M	Speed	Position	Accel	Decel	PushingF	TriggerLV	PushingSp	MovingF	Area1	Area2	In pos
		mm/s	mm	mm/s <sup>2</sup>	mm/s <sup>2</sup>	%	%	mm/s	%	mm	mm	mm
0	Absolute	250	50.00	3000	3000	60	40	30	100	48.00	50.00	20.00
1	Absolute	250	0.00	3000	3000	0	0	1	100	0.00	2.00	0.50

[  ] Need to be set - [  ] Need to be adjusted as required.

[ × ] Not used. Items don't need to be changed.

**a** <  Movement MOD > When the absolute position is required, set Absolute.

When the relative position is required, set Relative.

Absolute: Distance from the origin position. / General setting method.

Relative: Feed from the current position. / This is used when simplified data.

**b** <  Speed > Transfer speed to the target position.

**c** <  Position > Target position.

The pushing starting position is set forward by 2mm or more of the pushing object.

**d** <  Acceleration > The parameter which defines how rapidly the actuator reaches the speed set in **b**.



The higher the set value, the faster it reaches the speed set in **b**.

→

**e** <  Deceleration > The parameter which defines how rapidly the actuator comes to stops.

The higher the set value, the quicker it stops.

**f** <  Pushing force > Pushing force ratio is defined.

/See 7.2  Caution(1) on p.41 and  Caution(13) on p.43

**g** <  Trigger LV > The condition at which INP output signal is turned on.

Set it at the value equivalent to the pushing force or less.



/See 7.2  Caution(1) on p.41

The INP output signal is given when the target force (Trigger LV) is achieved.

The INP output signal is turned on when the generated force exceeds the value.

**h** <  Pushing speed > The pushing speed

Set the speed in the following range. If the speed is too high, the actuator or work piece can be damaged by impact.

/See 7.2  Caution(1) on p.41 and  Caution(3) on p.42

**i** <  Moving force > The upper force limit for the pushing operation starting position

The force is automatically adjusted corresponding to the load.

/See 7.2  Caution(4) on p.42

**j** <  Area1, Area2 > This is the condition that turns on the AREA output signal.

The setting condition should be **Area 1 < Area 2**

It is possible to set at Relative operation.

The position will be Absolute (position from the origin).

**k** <  In position > The transfer distance (relative value) when pushing

If the transferred distance exceeds the setting, it stops even if it is not pushing.  
If the transfer distance is exceeded, the INP output signal will not be turned on.  
(incomplete pushing)

Example) In case of Step no.0

Position: 50 + In Position: 20 = 70

(The position where the incomplete pushing is detected.)

## Example of step data entry (1)

< Positioning operation - 【INP】output signal, 【AREA】output signal >

No.	Move M	Speed mm/s	Position mm	Accel mm/s <sup>2</sup>	Decel mm/s <sup>2</sup>	PushingF %	TriggerLV %	PushingSp mm/s	MovingF %	Area1 mm	Area2 mm	In pos mm
0	Absolute	100	100.00	3000	3000	0	0	0	100	80.00	90.00	0.50

### •Step data no.0 : Positioning operation (It moves from Position:0[mm] to Position:100[mm])

Condition 1) The 【AREA】output signal is not used.

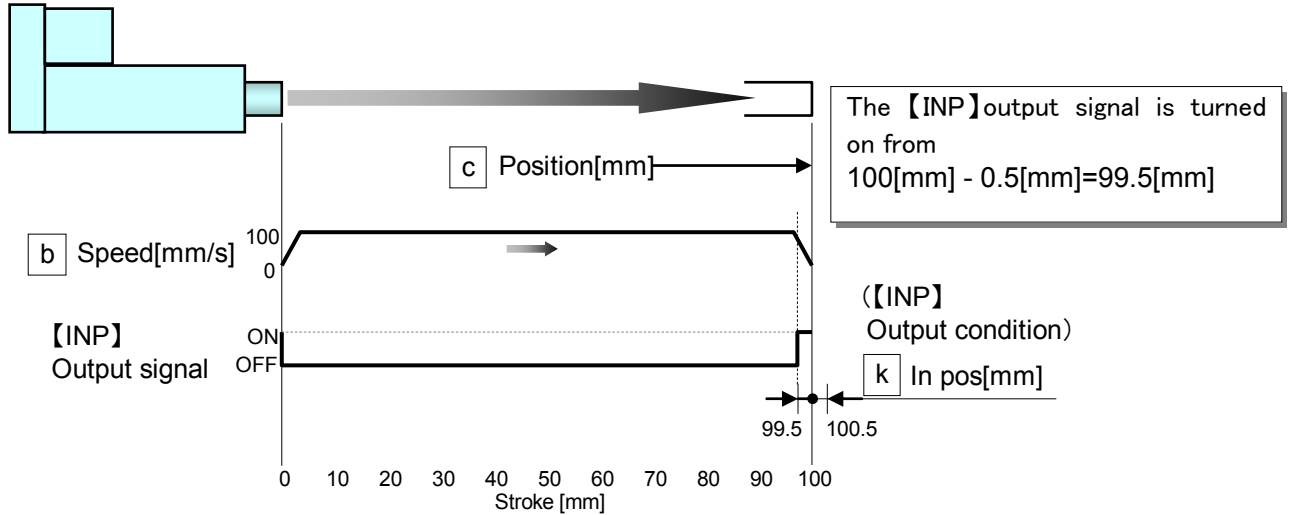

Condition 2) The 【AREA】output signal is used.

\*The 【AREA】output signal is a signal output when the rod traverses through a certain range (The step data: **Area 2** from **Area 1**).

This feature is useful when an output to check the rod position at intermediate stroke is required.

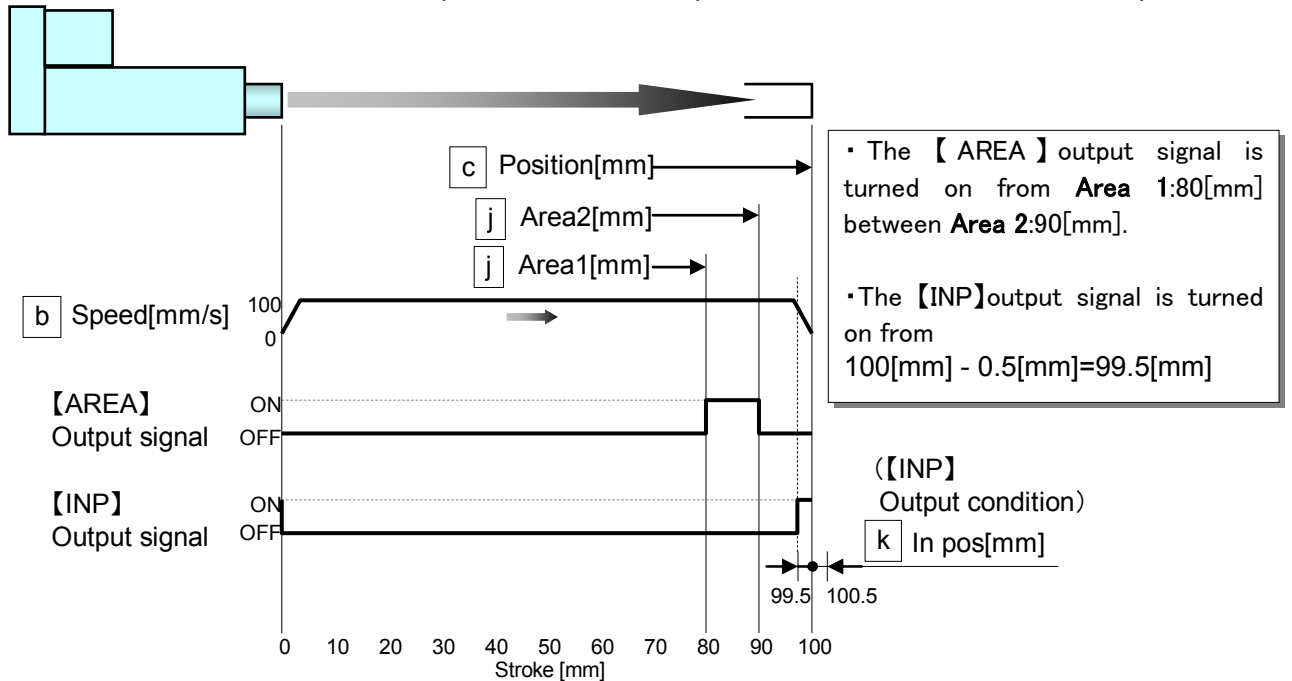

## Example of step data entry (2)

< Pushing operation - 【INP】output signal, 【AREA】output signal >

No.	Move M	Speed mm/s	Position mm	Accel mm/s <sup>2</sup>	Decel mm/s <sup>2</sup>	PushingF %	TriggerLV %	PushingSp mm/s	MovingF %	Area1 mm	Area2 mm	In pos mm
0	ABS	100	80.00	3000	3000	80	40	30	100	70.00	100.00	25.00

**•Step data no.0 : Positioning operation. (It moves to End limit after it moves from 0mm to 80mm.)**

Condition 1) The 【AREA】output signal is not used.

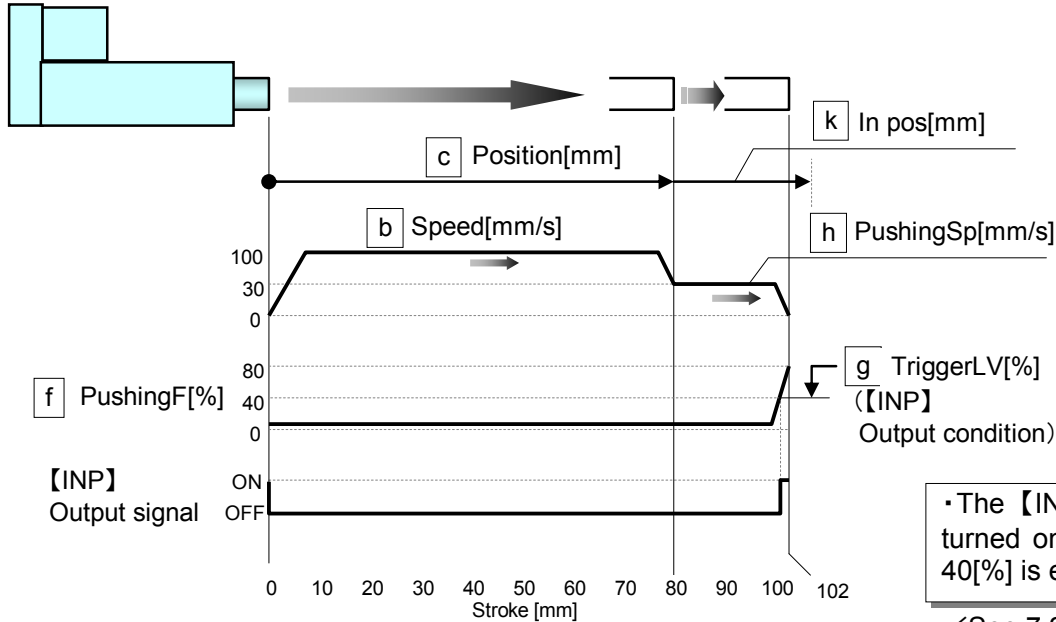

Condition 2) The 【AREA】output signal is used.

\* The 【AREA】output signal is a signal output when the rod traverses through a certain range (The step data: **Area 2** from **Area 1**).

This feature is useful when an output to check the rod position at intermediate stroke is required.

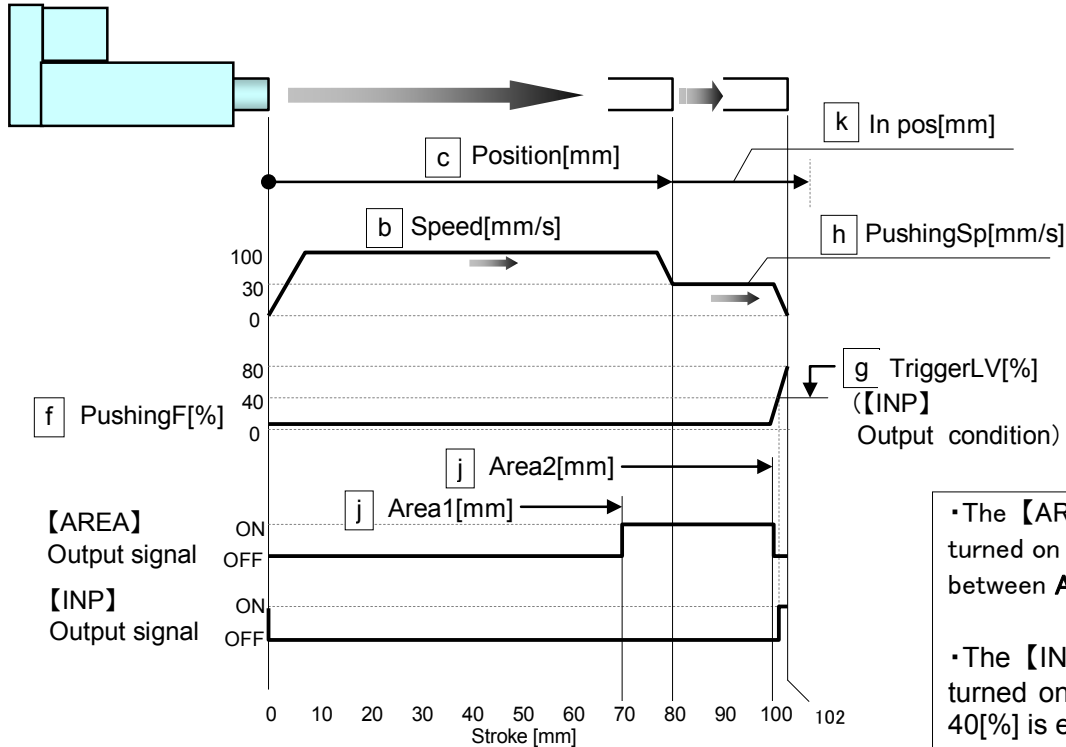

## Example of step data entry (3)

### < Positioning operation - Relative >

	a	b	c	d	e	f	g	h	i	j	k	
No.	Move M	Speed mm/s	Position mm	Accel mm/s <sup>2</sup>	Decel mm/s <sup>2</sup>	PushingF %	TriggerLV %	PushingSp mm/s	MovingF %	Area1 mm	Area2 mm	In pos mm
0	Relative	100	10.00	3000	3000	0	0	0	100	10.00	20.00	0.50
1	Relative	100	-10.00	3000	3000	0	0	0	100	10.00	20.00	0.50

\*Absolute: Distance from the origin position.

\*Relative: Feed from the current position.

Condition 1) 30mm position → **Step no.0** → **Step no.0** (Move M: Relative)

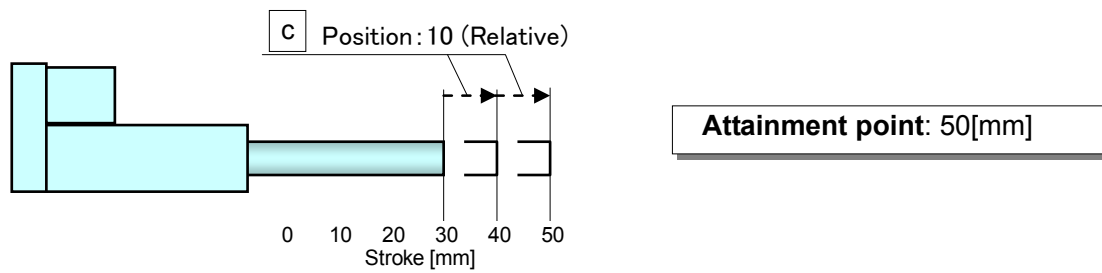

Condition 2) 30mm position → **Step no.1** → **Step no.1** (Move M: Relative)

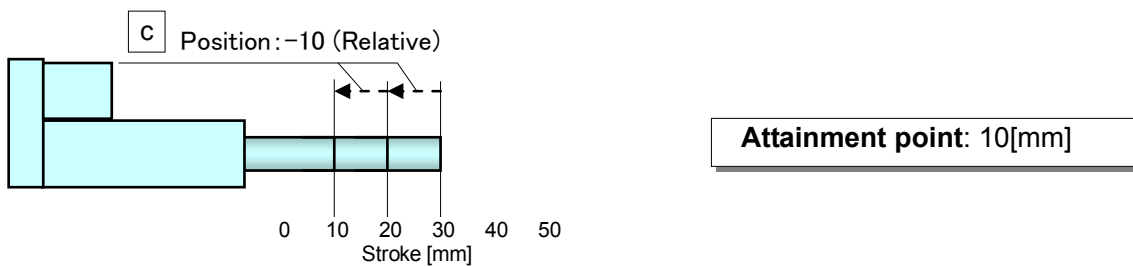

## Example of step data entry (4)

### < Pushing operation - In position >

	a	b	c	d	e	f	g	h	i	j	k	
No.	Move M	Speed mm/s	Position mm	Accel mm/s <sup>2</sup>	Decel mm/s <sup>2</sup>	PushingF %	TriggerLV %	PushingSp mm/s	MovingF %	Area1 mm	Area2 mm	In pos mm
0	Absolute	100	20.00	3000	3000	80	40	30	100	10.00	20.00	20.00

**•Step data no.0 : Pushing operation ("Pushing operation" is done during 20mm after it moves from 0mm to 20mm.)**

Condition 1) Length to work < In position

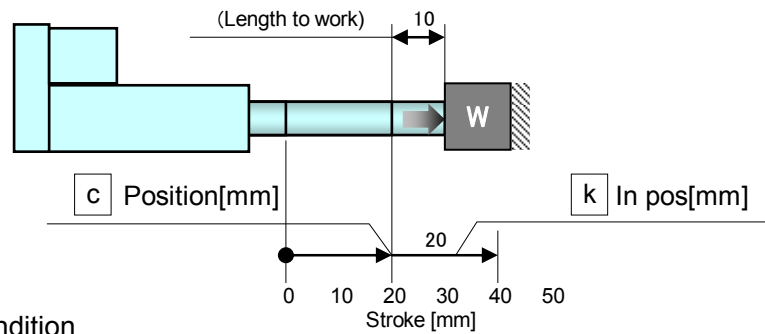

**【INP】Output condition**

- **k** In pos  $\geq$  Length to work
- Actual force  $\geq$  **g** TriggerLV

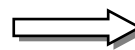

The **【INP】** output signal is turned on

Condition 2) Length to work > In position

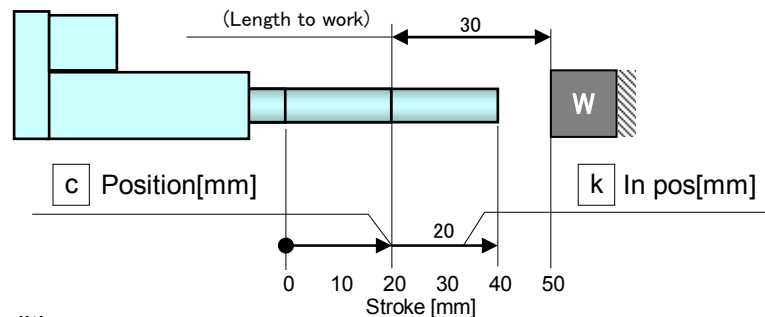

**【INP】Output condition**

- **k** In pos < Length to work
- Actual force < **g** TriggerLV

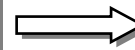

The **【INP】** output signal is not turned on  
The **【BUSY】** output signal is turned off



## Example of step data entry (4)

### < Pushing operation – Driving starting position >

The pushing action is different and dependent upon the starting position and direction.  
Confirm the position where the pushing operation starts.

No.	Move M	Speed mm/s	Position mm	Accel mm/s <sup>2</sup>	Decel mm/s <sup>2</sup>	PushingF %	TriggerLV %	PushingSp mm/s	MovingF %	Area1 mm	Area2 mm	In pos mm
0	Absolute	100	0.00	3000	3000	0	0	0	100	10.00	20.00	0.50
1	Absolute	100	50.00	3000	3000	0	0	0	100	10.00	20.00	0.50
2	Absolute	100	30.00	3000	3000	80	40	30	100	10.00	20.00	10.00

Condition 1) In case the pushing operation is **Step no.0** to **Step no.2**.

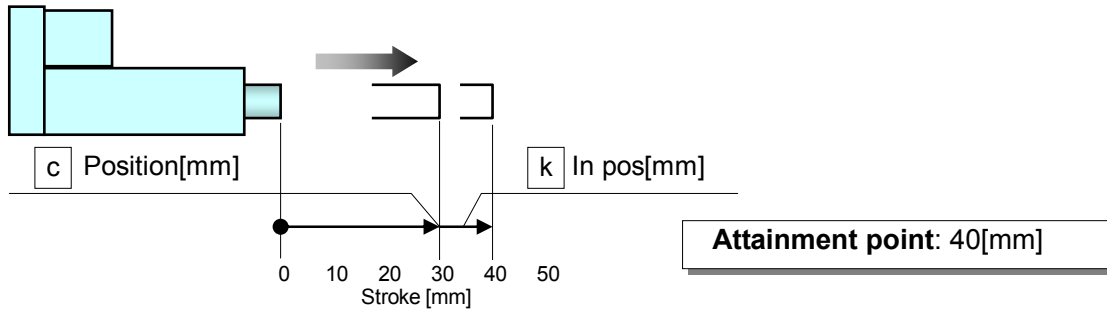

Condition 2) In case the pushing operation is **Step no.1** to **Step no.2**.

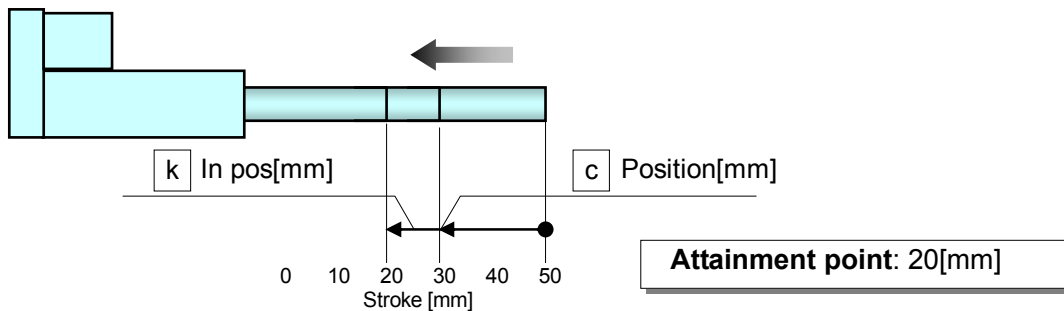

## Operating procedure and input / output signals for each operation

The input / output signal and the operation description for operating this electric actuator are as follows.

### 1) Signals along with the operation procedures

In case the operation order is

1. Supply power to the motor → 2. Return to origin → 3. Step no. 1 → 4. Step no. 2 → 5. Cutting power to the motor

Procedure	Input signal	Output signal to the input signal	Operation description
1	SVON(Servo on)[ ● ]	SVRE(Servo ready) [ ● ]	Power is supplied to the motor, and detection of the magnetic pole position. =>Complete.
2	SETUP [ ● ]	SETON [ ● ] INP(IN position)[ ● ]	Return to the origin. =>Complete.
3	IN0 [ ● ] IN1 [ ] IN2 [ ] IN3 [ ] IN4 [ ] IN5 [ ] ↓ DRIVE [ ● ] => [ ] note.3)5)	OUT0 [ ● ] OUT1 [ ] OUT2 [ ] OUT3 [ ] OUT4 [ ] OUT5 [ ] } note.3)4) ↓ After reaching of target position, INP [ ● ] After stopping motion, BUSY [ ]	Step no. 1 is selected, and the operation starts. =>Completion.
4	IN0 [ ] IN1 [ ● ] IN2 [ ] IN3 [ ] IN4 [ ] IN5 [ ] ↓ DRIVE [ ● ] => [ ] note.3)5)	OUT0 [ ] OUT1 [ ● ] OUT2 [ ] OUT3 [ ] OUT4 [ ] OUT5 [ ] } note.3)4) ↓ After reaching of target position, INP [ ● ] After stopping motion, BUSY [ ]	Select the step no. 2, and the operation starts. =>Complete.
5	SVON [ ]	SVRE [ ] SETON [ ● ] note.2) INP [ ● ]	Power to the motor is cut.

Note 1) [●] means ON, [ ] means OFF.

Note 2) The origin has been recognized when the operation is repeated, so it can operate without the procedure item 2.

Note 3) The “OUT\*” signals are reset during the rising edge of the Drive signal. The “OUT\*” signal which follows the “IN\*” signal are outputted at the falling edge of the “DRIVE” signal.

Note 4) When the alarm is generated, the alarm group is displayed.  
Please confirm controller (LEC series) manual for a detailed content of the alarm.

Note 5) Leave an interval of 15ms (the recommendation is 30ms) or more between input signals and maintain the state of the signal for 15ms (the recommendation is 30ms) or more, because PLC processing delays and controller scanning delays can occur.

## 2) Signals when Stopped: In the event when “EMG” is used

/ See 6.1 Caution (9) on p.36

The operating sequence is **1.”Stop”** → **2.Release the “Stop”**

Procedure	Input signal	Output signal to the input signal	Operation description
1	EMG:Not energizing (TB / Stop switch:Locking)	*ESTOP [ ] SVRE [ ] SETON [ • ]	Power to the motor is cut by the “Stop” command regardless of whether it is operating or stopping.
2	EMG:Energizing (TB / Stop switch:Releasing)	* ESTOP [ • ] SVRE [ • ] SETON [ • ] Note 2)	The stop is released.

Note 1) [•] means ON, [ ] means OFF. \*means negative logic

Note 2) SETON signal does not change after releasing the “STOP”

Note 3) If the stop is input from the EMG or RESET terminal or the stop-switch on the connected Teaching Box during pushing operation, the actuator stop.  
 (“Busy” signal turns OFF) And if the actuator stop within the range of “Position” ± “In pos” defined in step data, output signal “INP” turns ON.

## 4.4 Parameter setting

### Initial setting for the basic parameters

Refer to the controller's (LEC series) operation manual for detail.

As the "basic parameter" is unique data of each actuator, if an actuator other than the "electric actuator / rod type" is used, refer to the operation manual of each actuator and the controller's (LEC series)

Description(Extract)	Initial input value	Input range
Controller ID	1	1 to 64 Note 1)
IO pattern	1: 64	-
Acceleration / deceleration pattern	1: Trapezoid - motion	-
S-motion ratio	0	-
Stroke (+)	1000.00	-
Stroke (-)	-1000.00	-
Maximum speed	Max. speed of each product	Step data input limit: Max. speed of each product
Maximum acceleration / deceleration	3000	to 3000
Default In positioning	0.5	0.5 to product stroke
Origin offset	0.00	-9000.00 to 9000.00 Note 2)
Maximum pushing force	LEY 16 : 85	to 85
	LEY 25 : 65	to 65
	LEY 32 : 85	to 85
	LEY 16A : 95	to 95
	LEY 25A : 95	to 95
Parameter protect	1: Common + StepData	Changeable parameter 1: Common + StepData, 2: Common
Enable switch	2: Disable	Select 1:Enable or 2:Disable when using a teaching box
Model name	Part no. of each product	Only the English characters and numbers are changeable.
W-area output end 1	0.00	-
W-area output end 2	0.00	-
Origin correction data	0.00	-

Note1) Become effective after restarting the controller.

Note 2)The origin offset is used for the "return to origin". / See 2) Origin offset on p.33

### <Return to origin>

Before the positioning and pushing operation, "return to origin" is necessary to establish the origin. The current position value of the actuator increases if the rod extend (move in the CW direction). (The rod moving direction to be increased cannot be changed.)

#### 1) Flow of return to origin

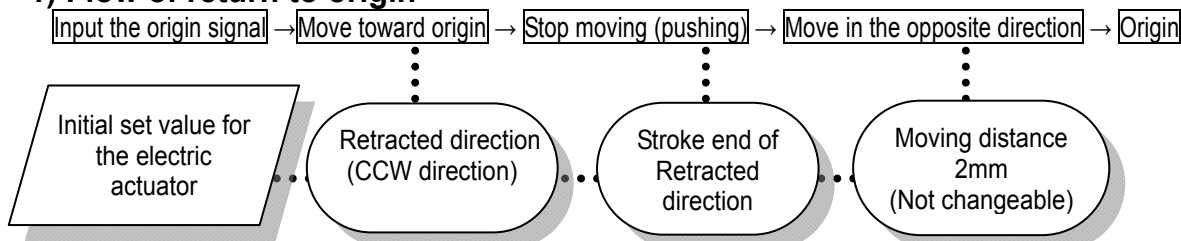

## 2) Origin offset

The origin offset means the value of the origin. ("Origin offset"=origin)

When the parameter "Origin offset" is changed, the value of "Stroke(+)", "Stroke(-)" of basic parameter should be checked again.

Initial input value: "Origin offset"=0

Move in the opposite direction (Moving distance 2mm / Not changeable) by the return to origin becomes "origin =0".

### a) Origin direction: CCW

Example) Actuator stroke 50mm

"Origin offset"=0 (Initial input value)

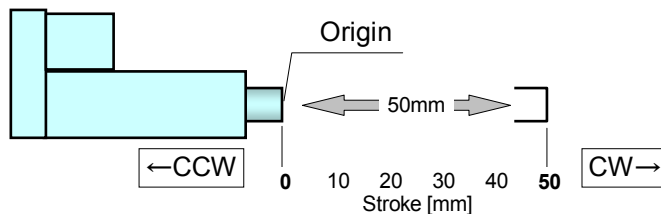

"Origin offset"=10

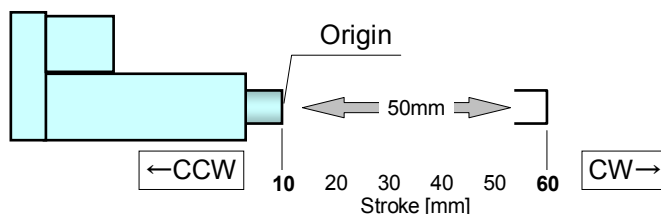

### b) Origin direction: CW

Example) Actuator stroke 50mm

"Origin offset"=0 (Initial input value)

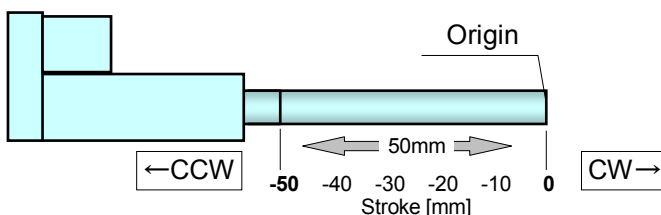

"Origin offset"=10

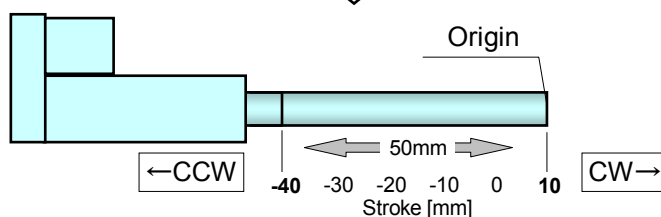

"Origin offset"=-10

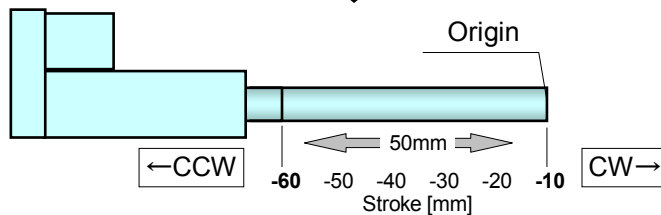

## Initial setting for the ORIG parameters

Refer to the controller's (LEC series) operation manual for detail.

As the "ORIG parameter" is unique data of each actuator, if an actuator other than the "electric actuator / rod type" is used, refer to the operation manual of each actuator and the controller's (LEC series) operation manual for the ORIG parameter.

Description (Extract)	Initial input value	Input range
ORIG direction	note1) CCW	1: CW , 2: CCW
ORIG mode	1:ORIG Press	-
ORIG limit	LEY16:100, LEY25:100, LEY32:100 LEY16A:150, LEY25A:200	-
ORIG time	100	-
ORIG speed	20	to 50 / LEY16* to 35 / LEY25* to 30 / LEY32
ORIG ACC /DEC	1000	-
Creep speed	10	-
ORIG sensor	0: Disable	-

Note1) CCW direction: Retracted CW direction: Extended. Become effective after restarting the controller.

Note 2) Return to origin cannot return while operating / See 6.1⚠caution(4) on p.37

### ⚠WARNING

Do not alter any parameter except the ones shown. Or else there is a possibility of damage.

## 2) Method of changing direction of origin

Use the following procedures when you change the direction of the origin.

Procedure 1- In the [Parameter] 01 dialogue box select the ORIG tab.

And the direction of the starting point return is changed from CCW to CW.

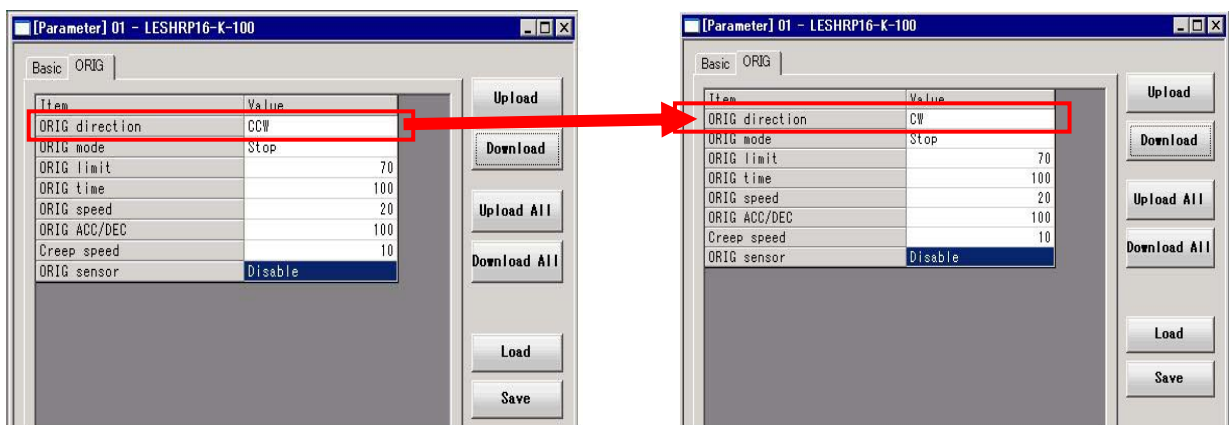

Procedure 2- In the [Parameter] 01 dialogue box press the "Download All" radio button.

Procedure 3- Power supply OFF (→ Power supply ON)

## 5. Wiring of cables / Common precautions

### ⚠ Warning

1. **Adjusting, mounting or wiring change should never be done before shutting off the power supply to the product.**  
Electrical shock, malfunction and damaged can result.
2. **Never disassemble the cable. Use only specified cables.**
3. **Never connect or disconnect the cable or connector with power on.**

### ⚠ Caution

1. **Wire the connector securely. Do not apply any voltage to the terminals other than those specified in the product manual.**
2. **Wire the connector securely.**  
Check for correct connector wiring and polarity.
3. **Take appropriate measures against noise.**  
Noise in a signal line may cause malfunction. As a countermeasure, separate high voltage and low voltage cables, and shorten wiring lengths, etc.
4. **Do not route wires and cables together with power or high voltage cables.**  
The product can malfunction due to interference of noise and surge voltage from power and high voltage cables to the signal line. Route the wires of the product separately from power or high voltage cables.
5. **Take care that actuator movement does not catch cables.**
6. **Operate with cables secured. Avoid bending cables at sharp angles where they enter the product.**
7. **Avoid twisting, folding, rotating or applying an external force to the cable.**  
Risk of electric shock, wire break, contact failure and loss of control for the product can happen.
8. **Fix the cable protruding from the product in place before using.**  
The motor and lock cables are not robotic type cables and can be damaged when moved. Therefore fix the cables and the connectors (part "A" in figure below) when set up.

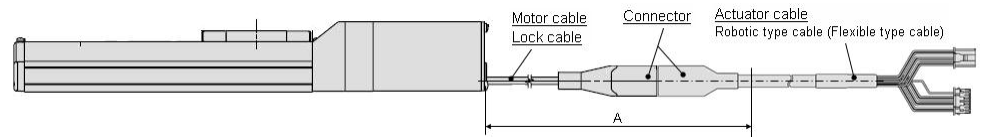

9. **Select "Robotic type cables" in case of inflecting actuator-cable repeatedly. And do not put cables into a flexible moving tube with a radius smaller than the specified value. (Min. 50mm).**  
Risk of electric shock, wire break, contact failure and loss of control for the product can happen if "Standard cables" are used in case of inflecting the cables repeatedly.

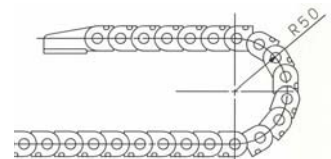

10. **Confirm proper wiring of the product.**  
Poor insulation (interference with other circuits, poor insulation between terminals and etc.) can apply excessive voltage or current to the product causing damage.
11. **The Speed / pushing force may vary, depending on the cable length, load and mounting conditions etc..**  
If the cable length exceeds 5m, the speed / pushing force will be reduced 10% per 5m as the maximum. (If cable length is 15m: 20% reduction as the maximum. )

## [Transportation]

### ⚠ Caution

1. **Do not carry or swing the product by the cable**

## 6. Electric actuators / Common precautions

### 6.1 Design and selection

#### Warning

- 1. Be sure to read the Operation Manual (this manual and the one for the controller: LEC series).**

Handling or usage/operation other than that specified in the Operation Manual may lead to breakage and operation failure of the product.  
Any damage attributed to the use beyond the specifications is not guaranteed.
- 2. There is a possibility of dangerous sudden action by the product if sliding parts of machinery are twisted due to external forces etc.**

In such cases, human injury may occur, such as by catching hands or feet in the machinery, or damage to the machinery itself may occur. Design the machinery should be designed to avoid such dangers.
- 3. A protective cover is recommended to minimize the risk of personal injury.**

If a driven object and moving parts of the product are in close proximity, personal injury may occur. Design the system to avoid contact with the human body.
- 4. Securely tighten all stationary parts and connected parts so that they will not become loose.**

When the product operates with high frequency or is installed where there is a lot of vibration, ensure that all parts remain secure.
- 5. Consider a possible loss of power source.**

Take measures to prevent injury and equipment damage even in the case of a power source failure.
- 6. Consider behavior of emergency stop of whole system.**

Design the system so that human injury and/or damage to machinery and equipment will not be caused, when it is stopped by a safety device for abnormal conditions such as a power outage or a manual emergency stop of whole system.
- 7. Consider the action when operation is restarted after an emergency stop or abnormal stop of whole system.**

Design the system so that human injury or equipment damage will not occur upon restart of operation of whole system.
- 8. Disassembly and modification is prohibited**

Do not modify or reconstruct (including additional machining) the product. An injury or failure can result.
- 9. Do not use the stop signal, "EMG" of the controller and stop switch on the teaching box as the emergency stop of system.**

The stop signal, "EMG" of controller and the stop switch on the teaching box are for decelerating and stopping the actuator.  
Design the system with an emergency stop circuit which is applied relevant safety standard separately.
- 10. When using it for vertical application, it is necessary to build in a safety device.**

The rod may fall due to the weight of work. The safety device should not interfere with normal operation of the machine.

#### Caution

- 1. Operate within the limits of the maximum usable stroke.**

The product will be damaged if it is used with the stroke which is over the maximum stroke. Refer to the specifications of the product.
- 2. When the product repeatedly cycles with partial strokes, operate it at a full stroke at least once every 10 strokes.**

Otherwise, lubrication can run out.
- 3. Do not use the product in applications where excessive external force or impact force is applied to it.**

The product can be damaged.



**4. Rerutting to origin cannot be done during the operation.**

It cannot be done during positioning operation, pushing operation and pushing.

**5. Refer to a common auto switch /matter (Best Pneumatics No 2) when an auto switch is built in and used.**

## 6.2 Mounting

### Warning

**1. Install and operate the product only after reading the Operation Manual carefully and understanding its contents. Keep the manual in a safe place future reference.**

**2. Observe the tightening torque for screws.**

Tighten the screws to the recommended torque for mounting the product.

**3. Do not make any alterations to this product.**

Alterations made to this product may lead to a loss of durability and damage to the product, which can lead to human injury and damage to other equipment and machinery.

**4. When using external guide, the guide axis should be parallel to the actuator axis.**

There will be damage/excessive wear on the lead screw if the external guide is not parallel.

**5. When an external guide is used, connect the moving parts of the product and the load in such a way that there is no interference at any point within the stroke.**

Do not scratch or dent the sliding parts of the product tube or piston rod etc., by striking or grasping them with other objects. Components are manufactured to precise tolerances, so that even a slight deformation may cause faulty operation.

**6. Prevent the seizure of rotating parts.**

Prevent the seizure of rotating parts (pins, etc.) by applying grease.

**7. Do not use the product until you verify that the equipment can operate properly.**

After mounting or repair, connect the power supply to the product and perform appropriate functional inspections to check it is mounted properly.

**8. Cantilever**

When the actuator is operated at high speed while it is fixed at one end and free at the other end (flange type, foot type, double clevis type, direct mount type), a bending moment may act on the actuator due to vibration generated at the stroke end, which can damage the actuator. In such a case, install a support bracket to suppress the vibration of the actuator body or reduce the speed so that the actuator does not vibrate. Use a support bracket also when moving the actuator body or when a long stroke actuator is mounted horizontally and fixed at one end.

**9. When attaching work piece, do not apply strong impact or large moment.**

If an external force over the allowable moment is applied, it may cause looseness in the guide unit, an increase in sliding resistance or other problems.

**10. Maintenance space**

Allow sufficient space for maintenance and inspection.

## 6.3 Handling

### Warning

- 1. Do not touch the motor while in operation.**

The surface temperature of the motor can increase to approx. 90°C to 100°C due to operating conditions. Energizing alone may also cause this temperature increase. As it may cause burns, do not touch the motor when in operation.
- 2. If abnormal heating, smoking or fire, etc., occurs in the product, immediately shut off the power supply.**
- 3. Immediately stop operation if abnormal operation noise or vibration occurs.**

If abnormal operation noise or vibration occurs, the product may have been mounted incorrectly. Unless operation of the product is stopped for inspection, the product can be seriously damaged.
- 4. Never touch the rotating part of the motor or moving part of the actuator while in operation.**
- 5. When installing, adjusting, inspecting or performing maintenance on the product, controller and related equipment, be sure to shut off the power supply to them. Then, lock it so that no one other than the person working can turn the power on, or implement measures such as a safety plug.**
- 6. In the case of the actuator that has a servo motor (24VDC), the “motor phase detection step” is done by inputting the servo on signal just after the controller power is turned on. The “motor phase detection step” moves the table/rod for the distance of the one screw-lead as the maximum. (The motor rotates in the reverse direction if the table hits an obstacle such as the end stop damper.) Take the “motor phase detection step” into consideration for the installation and operation of this actuator.**

### Caution

- 1. Keep the controller and product combined as delivered for use.**

The product is set in parameters for shipment. If it is combined with a different parameter, failure can result.
- 2. Check the product for the following points before operation.**
  - a) Damage to power supply line and signal line.
  - b) Looseness of the connector to each power line and signal line.
  - c) Looseness of the actuator /cylinder and controller /driver mounting
  - d) Abnormal operation
  - e) Emergency stop of the total system
- 3. When more than one person is performing work, decide on the procedures, signals, measures and resolution for abnormal conditions before beginning the work. Also, designate a person to supervise work other than those performing work.**
- 4. Actual speed of the product will be changed by the workload.**

Before selecting a product, check the catalog for the instructions regarding selection and specifications.
- 5. Do not apply a load, impact or resistance in addition to a transferred load during return to origin.**

In the case of the return to origin by pushing force, additional force will cause displacement of the origin position since it is based on detected motor torque.
- 6. Do not remove the nameplate.**
- 7. Operation test should be done by low speed. Start operation by predefined speed after confirming there is no trouble.**

## [Ground]

### Warning

- 1. Please give the ground to the actuator.**
- 2. The ground should be exclusive use. (Less than 100Ω)**
- 3. The ground cable length should be as short as possible.**

## [Unpackaging]



### Caution

1. **Check the received product is as ordered.**

If the different product is installed from the one ordered, injury or damage can result.

## 6.4 Operating environment



### Warning

1. **Avoid use in the following environments.**

- a. Locations where a large amount of dusts and cutting chips are airborne.
- b. Locations where the ambient temperature is outside the range of the temperature specification (refer to specifications).
- c. Locations where the ambient humidity is outside the range of the humidity specification (refer to specifications).
- d. Locations where corrosive gas, flammable gas, sea water, water and steam are present.
- e. Locations where strong magnetic or electric fields are generated.
- f. Locations where direct vibration or impact is applied to the product.
- g. Areas that are dusty, or are exposed to splashes of water and oil drops.
- h. Areas exposed to direct sunlight (ultraviolet ray).

2. **Do not use in an environment where the product is directly exposed to liquid, such as cutting oils.**

If cutting oils, coolant or oil mist contaminates the product, failure or increased sliding resistance can result.

3. **Install a protective cover when the product is used in an environment directly exposed to foreign matters such as dust, cutting chips and spatter.**

Play or increased sliding resistance can result.

4. **Shade the sunlight in the place where the product is applied with direct sunshine.**

5. **Shield the product if there is a heat source nearby.**

When there is a heat source surrounding the product, the radiated heat from the heat source can increase the temperature of the product beyond the operating temperature range. Protect it with a cover, etc.

6. **Grease oil can be decreased due to external environment and operating conditions, and it deteriorates lubrication performance to shorten the life of the product.**

## [Storage]



### Warning

1. **Do not store the product in a place in direct contact with rain or water drops or is exposed to harmful gas or liquid.**
2. **Store in an area that is shaded from direct sunlight and has a temperature and humidity within the specified range (-10°C to 60°C and 90%RH or less No condensation or freezing).**
3. **Do not apply vibration and impact to the product during storage.**

## 6.5 Maintenance

### Warning

1. **Do not disassemble or repair the product.**

Fire or electric shock can result.

2. **Before modifying or checking the wiring, the voltage should be checked with a tester 5 minutes after the power supply is turned off.**

Electrical shock can result.

### Caution

1. **Maintenance should be performed according to the procedure indicated in the Operating Manual.**

Incorrect handling can cause an injury, damage or malfunction of equipment and machinery.

2. **Removal of product**

When equipment is serviced, first confirm that measures are in place to prevent dropping of work pieces and run-away of equipment, etc, and then cut the power supply to the system. When machinery is restarted, check that operation is normal with actuators in the proper positions.

## [Lubrication]

### Caution

1. **The product has been lubricated for life at manufacturer, and does not require lubrication in service.**

Contact SMC if lubrication will be applied.

## 6.6 Precautions for actuator with lock

### Warning

1. **Do not use the lock as a safety lock or a control that requires a locking force.**  
The lock used for the product with a lock is designed to prevent dropping of work piece.
2. **For vertical mounting, use the product with a lock.**  
If the product is not equipped with a lock, the product will move and drop the work piece when the power is removed.
3. **"Measures against drops" means preventing a work piece from dropping due to its weight when the product operation is stopped and the power supply is turned off.**
4. **Do not apply an impact load or strong vibration while the lock is activated.**  
If an external impact load or strong vibration is applied to the product, the lock will lose its holding force and damage to the sliding part of the lock or reduced lifetime can result. The same situations will happen when the lock slips due to a force higher than its holding force, as this will accelerate the wear to the lock.
5. **Do not apply liquid or oil and grease to the lock or its surrounding.**  
When liquid or oil and grease is applied to the sliding part of the lock, its holding force will be reduced significantly.
6. **Take measures against drops and check that safety is assured before mounting, adjustment and inspection of the product.**  
If the lock is released with the product mounted vertically, a work piece can drop due to its weight.
7. **When the actuator is operated manually (when SVRE output signal is off), supply 24DCV to the [BK RLS] terminal of the power supply connector.**  
If the product is operated without releasing the lock, wearing of the lock sliding surface will be accelerated, causing reduction in the holding force and the life of the locking mechanism.
8. **Do not supply 24VDC power supply constantly to the [BK RLS(Lock release)] terminal.**  
Stop supplying 24VDC power supply to the [BK RLS(Lock release) terminal during normal operation. If power is supplied to the [BK RLS] terminal continuously, the lock will be released, and workpieces may be dropped at stop (EMG).

**/Refer to the operation manual of LEC (controller) for details of wiring.**

## 7. Electric actuators / Common precautions

### 7.1 Design and selection

#### ⚠ Warning

**1. Do not apply a load in excess of the actuator specification.**

A product should be selected based on the maximum work load and allowable moment. If the product is used outside of the operating specification, eccentric load applied to the guide will become excessive and have adverse effects such as creating play at the guide, reduced accuracy and reduced product life.

**2. Do not use the product in applications where excessive external force or impact force is applied to it.**

This can lead to premature failure of the product.

**3. If using in a stopper application, please select the LEYG series "slide bearing".**

**4. If using in a stopper application, fix the body with the guide attachment.**

("Upper mounting" or "Lower mounting") / See 7.3 Mounting [LEYG series] on p.45

If the body is fixed at the end of the actuator (end mounting), excessive load will act on the actuator body, which may adversely affect the operation and life of the product.

### 7.2 Handling

#### ⚠ Caution

**1. INP output signal**

**1) Positioning operation**

When the product comes within the set range by **step data [In positon]**, output signal will be turned on. Initial value: Set to [0.50] or higher.

**2) Pushing operation**

When the pushing force exceeds the [TriggerLV] value the INP ( In position) output signal is turned on. Please set the [Pushing force] and the [TriggerLV] within the specified range.

a. To ensure that the actuator pushes the workpiece by the inputted [pushing force], it is recommended that the [TriggerLV] is set to the same value as the [pushing force].

b. When the [TriggerLV] and [pushing force] are set to be less than the lower limit of the specified range, there is the possibility that the INP output signal will be switched on from the pushing operation start position.

[Pushing force] and the [Trigger LV] within the limitation range

Model	Pushing speed [mm/sec]	Pushing force (Setting input value)	Model	Pushing speed [mm/sec]	Pushing force (Setting input value)
LEY*16**	1 to 4	30% to	LEY*16*A*	1 to 4	40% to
	5 to 20	35% to 85%		5 to 20	60% to 95%
	21 to 50	60% to		21 to 50	80% to
LEY*25**	1 to 4	20% to	LEY*25*A*	1 to 4	40% to
	5 to 20	35% to 65%		5 to 20	60% to 95%
	21 to 35	50% to		21 to 35	80% to
LEY*32**	1 to 4	20% to			
	5 to 20	35% to 85%			
	21 to 30	60% to			

Note) If there is a vertical load (rising), set the maximum value of "pushing force" and operate within the workload shown below.

Model	LEY*16**			LEY*25**			LEY*32**			LEY*16*A*			LEY*25*A*			
	lead	A	B	C	A	B	C	A	B	C	A	B	C	A	B	C
Work load[kg]	1	1.5	3	2.5	5	10	4.5	9	18	1	1.5	3	1.2	2.5	5	
Pushing force (Setting input value)	85%			65%			85%			95%			95%			

**2. When pushing operation, be sure to use in "pushing operation".**

**Also, do not hit the work piece in positioning operation or in the range of positioning operation.**

It causes the breakage and malfunction.

3. **Keep the specifications driving speed range for pushing operation.**  
It causes the breakage and malfunction.
4. **The positioning force should be set to “Initial input value”.**  
(LEY16/25/32\*:100%, LEY16A\*:150%, LEY25A\*:200%)  
If the positioning force is set below “Initial input value”, it can displace the tack time, which causes an alarm.
5. **Actual speed of the product can be changed by load.**  
When selecting a product, check the catalog for the instructions regarding selection and specifications.
6. **Do not apply a load, impact or resistance in addition to a transferred load during return to origin.**  
Otherwise, the origin can be displaced since it is based on detected motor torque.
7. **In pushing operation, set the product to a position of at least 2mm away from a work piece.**  
(This position is referred to as a pushing start position.)  
If the product is set to the same position as a work piece, the following alarm and unstable operation can occur.

**a. "Posn failde" alarm**

The product cannot reach a pushing start position due to the deviation of work pieces in width.

**b. "Pushing ALM" alarm**

The product is pushed back from a pushing start position after starting to push.

**c. "Err overflow" alarm**

The displacement at the pushing start position exceeds the specified range.

8. **Do not scratch or gouge the sliding parts of the piston rod, by striking or grasping them with other objects.**  
Piston rod is manufactured to precise tolerances, so that even a slight deformation may cause malfunction.
9. **Please connect it so that the impact and load may not be added to the rod from the side when external guide is used.**
10. **Please do not operate body itself by the piston rod fixing.**  
An excessive load joins the piston rod, and it causes defective operation and the longevity decrease.
11. **Avoid using the electric actuator in such a way that rotational torque would be applied to the piston rod. [LEY]**

If rotational torque is applied, the non-rotating guide will become deformed, thus affecting the non-rotating accuracy.

Refer to the table below for the approximate values of the allowable range of rotational torque.

Allowable rotational torque (N·m or less)	LEY16□	LEY25□	LEY32□
	0.8	1.1	1.4

To screw a bracket or a nut onto the threaded portion at the tip of the piston rod, make sure to retract the piston rod entirely, and place a wrench over the flat portion of the rod that protrudes. Tighten it by giving consideration to prevent the tightening torque from being applied to the non-rotating guide.



12. **When rotational torque is applied to the plate end, use within the allowable range. [LEYG series]**  
Excessive torque could cause the guide rod and bushing to be deformed, causing looseness of the guide or increase in sliding resistance.

The applied rotational torque should be less than the "Allowable Rotational Torque of Plate" in the table below.

Stroke [mm]		30	50	100	200	300
Allowable Rotational Torque of Plate[Nm]	LEYG16M	0.70	0.57	1.05	0.56	-
	LEYG25M	1.56	1.29	3.50	2.18	1.36
	LEYG32M	2.55	2.09	5.39	3.26	1.88
	LEYG16L	0.82	1.48	0.97	0.57	-
	LEYG25L	1.52	3.57	2.47	2.05	1.44
	LEYG32L	2.80	5.76	4.05	3.23	2.32

**13. Operate within the following ranges of the duty ratio when pushing operation.**

The duty ratio is a ratio at the time that can keep being pushed.

• Step motor(Servo DC24V)

**LEY16**

Operating temperature: 25°C or less

Pushing F (%)	Duty ratio (%)	Continuous Pushing time (minute)
85 or less	100	-

Operating temperature: 40°C

Pushing F (%)	Duty ratio (%)	Continuous Pushing time (minute)
40 or less	100	-
50	70	12
70	20	1.3
85	15	0.8

**LEY25**

Operating temperature: 40°C or less

Pushing F (%)	Duty ratio (%)	Continuous Pushing time (minute)
65 or less	100	-

**LEY32**

Operating temperature: 25°C or less

Pushing F (%)	Duty ratio (%)	Continuous Pushing time (minute)
85 or less	100	-

Operating temperature: 40°C

Pushing F (%)	Duty ratio (%)	Continuous Pushing time (minute)
65 or less	100	-
85	50	15

• Servo motor(DC24V)

**LEY16A**

Operating temperature: 40°C or less

Pushing F (%)	Duty ratio (%)	Continuous Pushing time (minute)
95 or less	100	-

**LEY25A**

Operating temperature: 40°C or less

Pushing F (%)	Duty ratio (%)	Continuous Pushing time (minute)
95 or less	100	-

**14. When mounting the actuator, leave a gap of 40mm or more to allow for bending of the actuator cable.**

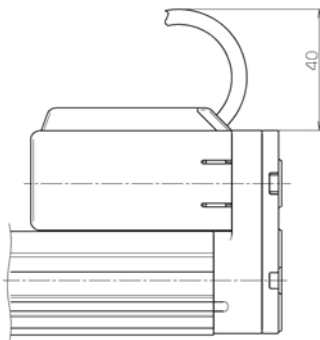



## 7.3 Mounting



### Caution

1. Fix 'Socket' square width across flats in the piston rod point with the spanner etc. , prevent the piston rod from rotating, and tighten the screw tightening when work piece or jig, etc. are installed properly by the torque value within the range of the limitation.

It causes the abnormal reaction of an auto switch, the space of an internal guide, and an increase of the sliding resistance, etc..

2. When mounting the workpiece or other device to the actuator tighten the fixing screws with adequate torque within the specified torque range.

Tightening the screws with a higher torque than the maximum may cause malfunction, whilst tightening with a lower torque can cause the displacement of the mounting position or in extreme conditions detaching of the work piece.

### [LEY series]

#### Work fixed / Rod end female thread

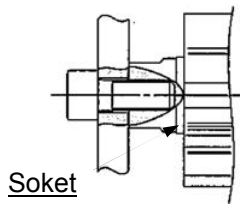

Model	Bolt	Max. tightening torque [Nm]	Max.thread depth [mm]	Scket width across flats [mm]
LEY16	M5x0.8	3.0	10	14
LEY25	M8x1.25	12.5	13	17
LEY32	M8x1.25	12.5	13	22

#### Work fixed / Rod end male thread

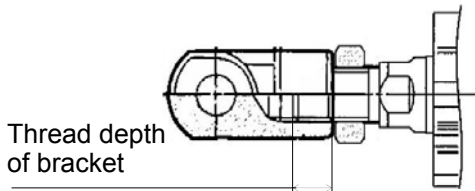
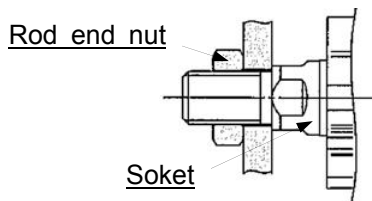

Model	Thread size	Max. tightening torque [Nm]	Max.thread depth [mm]	Scket width across flats [mm]
LEY16	M8x1.25	12.5	12	14
LEY25	M14x1.5	65.0	20.5	17
LEY32	M14x1.5	65.0	20.5	22
Model	Rod end nut		thread depth [mm]	
	Width across flats [mm]	Length [mm]		
LEY16	13	5	5 or more	
LEY25	22	8	8 or more	
LEY32	22	8	8 or more	

#### Mounting / Body bottom tapped style (When "Body bottom tappde" is selected)

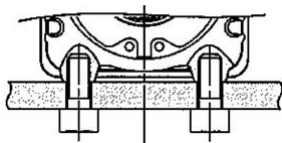

Model	Bolt	Max. tightening torque [Nm]	Max.thread depth [mm]
LEY16	M4x0.7	1.5	5.5
LEY25	M5x0.8	3.0	6.5
LEY32	M6x1.0	5.2	8.8

#### Mounting / Rod side•Head side tapped style

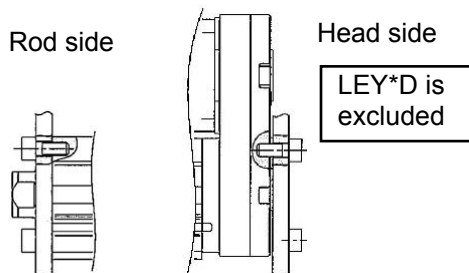

Model	Bolt	Max. tightening torque [Nm]	Max.thread depth [mm]
LEY16	M4x0.7	1.5	7
LEY25	M5x0.8	3.0	8
LEY32	M6x1.0	5.2	10

[LEYG series]

Work fixed/ Plate tapped style

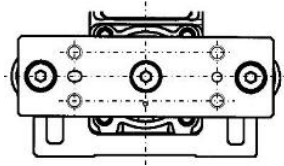

Model	Bolt	Max. tightening torque [N•m]	Max. thread depth [mm]
LEYG16 <sup>M</sup> <sub>L</sub>	M5 x 0.8	3.0	8
LEYG25 <sup>M</sup> <sub>L</sub>	M6 x 1.0	5.2	11
LEYG32 <sup>M</sup> <sub>L</sub>	M6 x 1.0	5.2	12

Mounting / Upper mounting tapped style

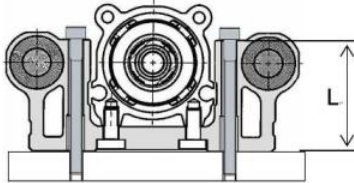

Model	Bolt	Max. tightening torque [N•m]	Length L [mm]
LEYG16 <sup>M</sup> <sub>L</sub>	M4 x 0.7	1.5	32
LEYG25 <sup>M</sup> <sub>L</sub>	M5 x 0.8	3.0	40.5
LEYG32 <sup>M</sup> <sub>L</sub>	M5 x 0.8	3.0	50.5

Mounting / Lower mounting tapped style

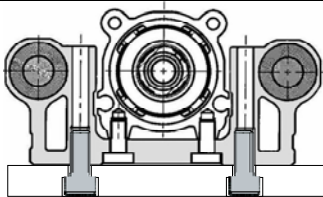

Model	Bolt	Max. tightening torque [N•m]	Max. thread depth [mm]
LEYG16 <sup>M</sup> <sub>L</sub>	M5 x 0.8	3.0	10
LEYG25 <sup>M</sup> <sub>L</sub>	M6 x 1.0	5.2	12
LEYG32 <sup>M</sup> <sub>L</sub>	M6 x 1.0	5.2	12

Mounting / Head side tapped style

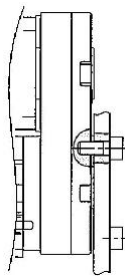

Model	Bolt	Max. tightening torque [N•m]	Max. thread depth [mm]
LEYG16 <sup>M</sup> <sub>L</sub>	M5 x 0.7	1.5	7
LEYG25 <sup>M</sup> <sub>L</sub>	M8 x 0.8	3.0	8
LEYG32 <sup>M</sup> <sub>L</sub>	M8 x 1.0	5.2	10

**3. Keep the flatness of the mounting surface within the following ranges when mounting the actuator body and work piece.**

Insufficient flatness of the work piece or the surface onto which the actuator body is to be mounted can cause increased sliding resistance.

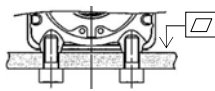
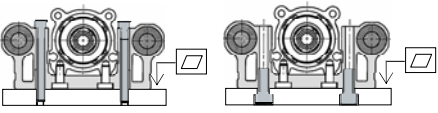
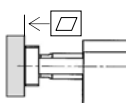
Model	Mounting part	Flatness
LEY*	Actuator body /Body bottom tapped style 	0.1mm or less
LEYG*	Actuator body / Upper mounting tapped style / Lower mounting tapped style 	0.05mm or less
	Work piece /Plate tapped style 	0.05mm or less

## 7.4 Precaution on maintenance

### Caution

1. Cut the power supply during maintenance and replacement of the product.

#### [ Maintenance frequency ]

Preform maintenance according to the table below.

	Appearance check	Check belt
Inspection before daily operation	○	
Inspection every six months *	○	○
Inspection every 250km *	○	○
Inspection are every five million times *	○	○

\*Either of inspection early time is selected.

#### [Items for visual appearance check]

1. Loose set screws, abnormal dirt.
2. Check of flaw and cable joint
3. Vibration, noise.

#### [Belt replacement]

It is recommended that the belt be replaced after 2 years or after following actuator movement distance. The life of the belt may be reduced due to operating conditions and the environment. Check the belt regularly as shown in “maintenance frequency” and replace belt if any abnormality is detected.

Model	Distance	Model	Distance	Model	Distance
LEY16*A	2,000km	LEY25*A	2,500km	LEY32A	4,000km
LEY16*B	1,000km	LEY25*B	1,200km	LEY32B	2,000km
LEY16*C	500km	LEY25*C	600km	LEY32C	1,000km

#### [Items for belt check]

Stop operation immediately and replace the belt when belt appear to be like photos below.

##### a. Tooth shape canvas is worn out

Canvas fiber becomes fuzzy. Rubber is removed and the fiber becomes whitish. Lines of fibers become unclear.



Teeth become fuzzy

##### b. Peeling off or wearing of the side of the belt

Belt corner becomes round and frayed thread sticks out.

##### c. Belt partially cut

Belt is partially cut. Foreign matter caught in teeth other than cut part causes flaw.



##### d. Vertical line of belt teeth

Flaw which is made when the belt runs on the flange.

##### e. Rubber back of the belt is softened and sticky.

##### f. Crack on the back of the belt



## 7.5 Replacement of belt

1. After Bolt is removed, "Pulley plate" is removed.

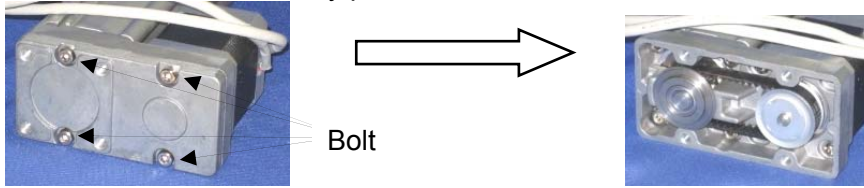

2. "Motor cover" and "Grommet" are removed. (Only "With motor cover")

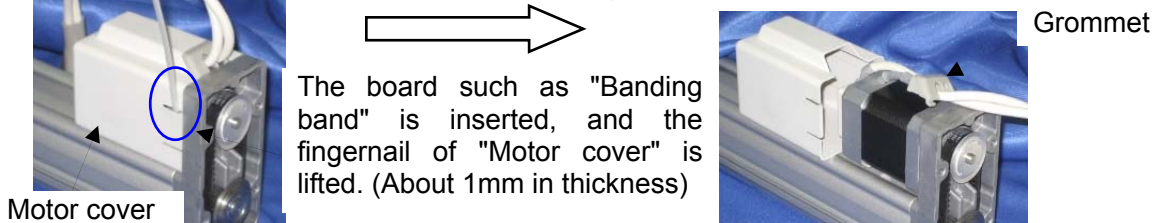

3. The bolt that is the fixation of "Motor" is loosened (To extent in which the slide can be done), and "Bearing support" is removed, and "Belt" is removed.

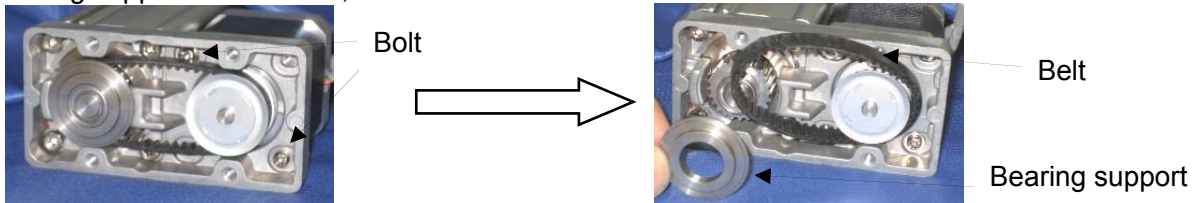

4. After "Belt" is installed, and the bearing support is obtained, the root of "Motor" is pulled in a string or a long banding band. With tensile force adjusted, tighten the bolts which fix the actuator to the motor. (See the table below)



Size	Belt Part number	Belt tension (N)	Tightening torque (Nm)
LEY16	LE-D-2-1	10	0.36
LEY25	LE-D-2-2	19	0.63
LEY32	LE-D-2-3	30	1.5

\*For LEY32: After the nut on Motor side is fixed by the spanner, it tightens a bolt.

5. "Pulley plate" is installed.

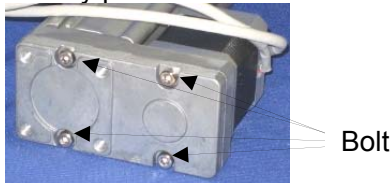

Size	Tightening torque (Nm)
LEY16	0.63
LEY25	1.5
LEY32	5.2

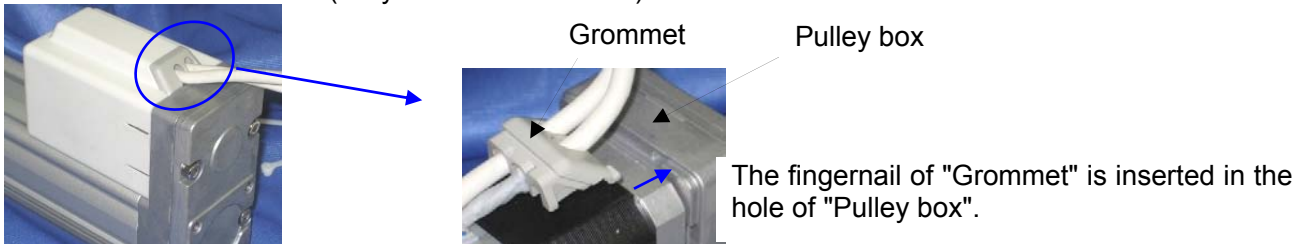

6. "Motor cover" is installed. (Only "With motor cover")



## 8. Troubleshooting

Alarms below are abstract of representative examples.

For other alarms, see operation manual of controller.

No.	Phenomenon	Cause	Countermeasure
1	Fall to operate / Initial stage	1) The cable is not connected or has been disconnected	Confirm that the cable is connected correctly. /See 5. Wiring of cable on p. 35
	When power is supplied, alarm for "Phase Det ALM /code: 1-193" is generated. ↓ <Procedure of restart> "Turn the power supply off." ↓ "Turn the power supply on"	2) The load / resistance being applied to the actuator constantly exceeds the actuators specification.	Keep the load / resistance within specified range. /See 2.1 Specifications on p.9-10 /See 3.1 Specifications on p.13-14
		3) The combination of the controller and actuator is not correct.	The controller and actuator combination at the time of shipment should not be changed. /See 6.3  Caution (1) on p.38
		4) Excessive external force is being applied, (including vibration) or impact load.	Operate within the specified range. /See 2.1 Specifications on p.9-10 /See 3.1 Specifications on p.13-14
		5) The tightening torque when the work piece and the actuator body are mounted exceeds the specified range.	Keep the tightening torque within specified range. /See 7.3 Mounting  Caution (1),(2) on p.44
		6) The flatness of work piece and the mounting surface exceeds the specified range.	Keep the flatness within specified range. /See 7.3 Mounting  Caution (3) on p.45
	Alarm for "Step data ALM1 /code:1-048" is generated ↓ <Procedure of restart> Input the "RESET" signal.	Setting condition for step data is not correct. < Correct set condition > (1)Area 1 < Area 2 (2) Trigger LV ≤ Pushing force (3) Pushing speed ≤ Speed (4) Pushing force ≥ Min. pushing force (20 %)	Review the content of step data. / Refer to the LEC controller operation manual.
Alarm for "Servo off ALM /code: 1-098" is generated ↓ <Procedure of restart> Input the "RESET" signal.	Perform the "Return to origin", the positioning operation and JOG operation during the "SVON": OFF.	Provide the operation instruction after confirming that the input signal [SVON] is ON and then the output signal [SVRE] is ON.	
Alarm for "Drive ALM /code: 1-099" is generated. ↓ <Procedure of restart> Input the "RESET" signal.	Perform positioning, pushing operation before the "return to origin".	Provide the operation instruction after confirming that the input signal [SETUP] is ON and then the output signal [SETON] is ON.	

No.	Phenomenon	Cause	Countermeasure
2	<p>Operation not completed / Operation continue</p> <p>Alarm for "Over load/code: 1-148" or "Posn failed/code: 1-149" is generated.</p> <p style="text-align: center;">↓</p> <p>&lt;Procedure of restart&gt; Controller version /SV1.0 or later 1. Input the "reset signal." →"SVRE": Automatically ON</p> <p>Controller version /SV0.8* or before 1. Input the "reset signal." →"SVRE": Automatically ON 2. Input the "setup signal." → Restart operation after the completion of the "return to origin".</p> <div style="border: 1px solid black; padding: 5px; margin-top: 10px;"> <p><u>Label position for controller version</u></p>  <p>Position : Bottom SV1.0*</p> </div>	1) The lead screw had galling due to excessive external force (including vibration) or impact.	Operate within the specified range. /See 2.1 Specifications on p.9-10 /See 3.1 Specifications on p.13-14
		2) The Power supply does not have sufficient capacity.	Check the power consumption for each actuator and controller: If necessary replace the existing power supply with a power supply with sufficient capacity. /See 2.1 Specifications on p.9-10 /See 3.1 Specifications on p.13-14
		3) Load/resistance more than specified range is being applied to the actuator.	Use within specification range. /See 2.1 Specifications on p.9-10 /See 3.1 Specifications on p.13-14 /See Catalog Model Selection "Speed-Vertical work load graph"
		4) The pushing operation is performed at the "Positioning operation" position.	Review the content of the step data. /See 7.2 ⚠Caution (2) on p.41
		5) For the pushing operation: The position and the target start pushing position are not set correctly.	Check the step data. /See 7.2 ⚠Caution (7) on p.42
		6) The cable is not connected or has been disconnected.	Confirm that the cable is connected correctly. /See 5. Wiring of cable on p.35
		7) It was not the intended origin position because the actuator pinched the work-piece during the "return to origin".	Remove the work-piece and restart the return to the intended origin position.
		8) Wrong input [0] is input as the positioning force.	Check the step data. <Moving force> /See 4.3 Step data setting on p.21
		9) The step data position is not changed correctly after the return to origin direction is changed.	Check the step data. <Position> /See 4.3 Step data setting on p.21 /See 4.4 Parameter setting on p.32
		10) Because the operation of the step data is set to [INC/relative], the table comes into contact with an external object and does not move due to continuous operation.  (Stroke end etc.)	Check the step data. <Position> /See 4.3 Step data setting on p.21  Check if correct operation instruction is provided.
		11) The tightening torque when the work piece and the actuator body are mounted exceeds the specified range.	Keep the tightening torque within specified range. /See 7.3 Mounting ⚠Caution (1),(2) on p.44
		12) The flatness of work piece and the mounting surface exceeds the specified range.	Keep the flatness within specified range. /See 7.3 Mounting ⚠Caution (3) on p.45



No.	Phenomenon	Cause	Countermeasure
2	Alarm for "Pushing ALM /code: 1-096" is generated.  ↓ <Procedure of restart> Controller version /SV1.0 or later 1. Input the "reset signal." →"SVRE": Automatically ON  Controller version /SV0.8* or before 1. Input the "reset signal." →"SVRE": Automatically ON 2. Input the "setup signal." → Restart operation after the completion of the "return to origin".	1) For the pushing operation, the position, target start-pushing position, is not set correctly.	Check the step data. /See 7.2 ⚠ Caution (7) on p.42
	Operation is not completed / Operation continue Alarm for "Over motor Vol /code: 1-145" is generated.  ↓ <Procedure of restart> Controller version /SV1.0 or later 1. Input the "reset signal." →"SVRE": Automatically ON  Controller version /SV0.8* or before 1. Input the "reset signal." →"SVRE": Automatically ON 2. Input the "setup signal." → Restart operation after the completion of the "return to origin".	2) It was not the intended origin position because the actuator pinched the work-piece during the "return to origin".	Remove the work-piece and restart the return to the intended origin position.
	Operation is not completed / Operation continue Alarm for "Over motor Vol /code: 1-145" is generated.  ↓ <Procedure of restart> Controller version /SV1.0 or later 1. Input the "reset signal." →"SVRE": Automatically ON  Controller version /SV0.8* or before 1. Input the "reset signal." →"SVRE": Automatically ON 2. Input the "setup signal." → Restart operation after the completion of the "return to origin".	1) If the power supply is an "inrush-current restraining type", the alarm may be generated due to voltage drop.	Replace the power supply with a non "inrush-current restraining type" power supply.  / Refer to the LEC controller operation manual.
	Operation is not completed / Operation continue Alarm for "Over motor Vol /code: 1-145" is generated.  ↓ <Procedure of restart> Controller version /SV1.0 or later 1. Input the "reset signal." →"SVRE": Automatically ON  Controller version /SV0.8* or before 1. Input the "reset signal." →"SVRE": Automatically ON 2. Input the "setup signal." → Restart operation after the completion of the "return to origin".	2) The Power supply does not have sufficient capacity.	Check the power consumption for each actuator and controller: If necessary replace the existing power supply with a power supply with sufficient capacity.  /See 2.1 Specifications on p.9-10 /See 3.1 Specifications on p.13-14

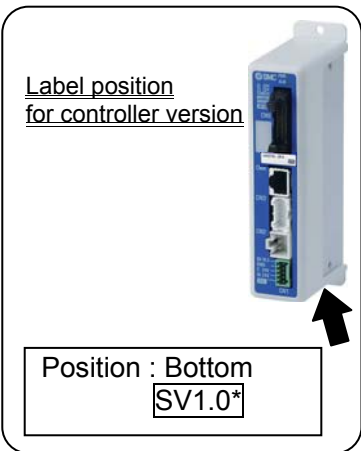



No.	Phenomenon	Cause	Countermeasure
2	Alarm for “ Err overflow /code: 1-196” is generated. ↓ <Procedure of restart> “Turn the power supply off.” ↓ “Turn the power supply on”	1) Added excessive external force (including vibration) or impact load.	Operate within the specified range. /See 2.1 Specifications on p.9-10 /See 3.1 Specifications on p.13-14
		2) The Power supply does not have sufficient capacity.	Check the power consumption for each actuator and controller: If necessary replace the existing power supply with a power supply with sufficient capacity. /See 2.1 Specifications on p.9-10 /See 3.1 Specifications on p.13-14
		3) Load/resistance more than specified range is being applied to the actuator.	Use within specification range. /See 2.1 Specifications on p.9-10 /See 3.1 Specifications on p.13-14 /See Catarg Model Selection “Speed-Vertical work load graph”
		4) The pushing operation is performed at the “Positioning operation position”	Review the content of the step data. /See 7.2⚠Caution (2) on p.41
		5) For the pushing operation: The position (the target start pushing position) is not set correctly.	Check the step data. /See 7.2⚠Caution (7) on p.42
		6) The cable is not connected or has been disconnected.	Confirm that the cable is connected correctly. /See 5. Wiring of cable on p.35
		7) It was not the intended origin position because the actuator pinched the work-piece during the “return to origin”.	Remove the work-piece and restart the return to the intended origin position.
		8) Wrong input [0] is input as the positioning force.	Check the step data. <Moving force> /See 4.3 Step data setting on p.21
		9) The step data position is not changed correctly after the return to origin direction is changed.	Check the step data. <Position> /See 4.3 Step data setting on p.21 /See 4.4 Parameter setting on p.32
		10) Because the operation of the step data is set to [INC/relative], the table comes into contact with an external object and does not move due to continuous operation. (Stroke end etc.)	Check the step data. <Position> /See 4.3 Step data setting on p.21 Check if correct operation instruction is provided.
		11) The tightening torque when the work piece and the actuator body are mounted exceeds the specified range.	Keep the tightening torque within specified range. /See 7.3 Mounting ⚠Caution (1),(2) on p.44
		12) The flatness of work piece and the mounting surface exceeds the specified range.	Keep the flatness within specified range. /See 7.3 Mounting ⚠Caution (3) on p.45



No.	Phenomenon	Cause	Countermeasure
2	Operation not completed / During operation  (Not always, but may happen occasionally)  Alarm for "Step data ALM2 /code: 1-051" is generated.  ↓  <Procedure of restart>  Input the "reset" signal.	1) Command invalid (unregistered) step data.	Check if the step data is valid (registered).
		2) Different input signal to the expected step number is inputted to the controller, because of a too short an interval between the input signal of the "IN*" and the "Drive" or inputting the signals at the same time.	Add an interval of 15ms (the recommendation is 30ms) or more between the input signals. / See "Operating procedure input and output signals for each operation type" on P.30
		3) Different input signal to the expected step number is inputted to the controller, because the input signal time was too short.	Maintain the state of the input signal for 15ms (the recommendation is 30ms) or more . / See "Operating procedure input and output signals for each operation type" on P.30
		4) Different input signal to the expected step number is inputted to the controller, caused by PLC or other device.	Check that the step number is inputted correctly for the required motion.
	- Operation completed by unexpected motion.  - No alarm  / During operation  (Not always, but may happen occasionally)	1) Different input signal to the expected step number is inputted to the controller, because of a too short an interval between the input signal of the "IN*" and the "Drive" or inputting the signals at the same time.	Add an interval of 15ms (the recommendation is 30ms) or more between the input signals. / See "Operating procedure input and output signals for each operation type" on P.30  Note) Recommend to check the "OUT" output signal for more secure operation.
		2) Different input signal to the expected step number is inputted to the controller, because the input signal time was too short.	Maintain the state of the input signal for 15ms (the recommendation is 30ms) or more . / See "Operating procedure input and output signals for each operation type" on P.30 Note) Recommend to check the "OUT" output signal for more secure operation.
		3) Different input signal to the expected step number is inputted to the controller, caused by PLC or other device.	Check that the step number is inputted correctly for the required motion. / See "Operating procedure input and output signals for each operation type" on P.30 Note) Recommend to check the "OUT" output signal for more secure operation.

No.	Phenomenon	Cause	Countermeasure
3	"Output signal" unstable the "INP output signal" turns "ON" before pushing the work piece.	1) "INP output signal" turns "ON" because the actual pushing force exceeds "TriggerLV".	Set the "Pushing force" and the "TriggerLV" within the specified range for the "Pushing speed"  /See 7.2  Caution (1) on p.41
	"Output signal" is unstable when pushing the work piece.  1. INP output signal When pushing work piece: "ON" ↓ Momentary "OFF" ↓ "ON"  2. BUSY output signal When pushing work piece: "OFF" ↓ Momentary "ON" ↓ "OFF"	1) Situation of pushing the work-piece is unstable.  Pushing the work piece in a position that allows the attachment to catch on the work piece.  ↓ Work piece slipped.  ↓ Re-holding the work piece.	Change the shape of the attachment to avoid being caught by the work-piece and to avoid slipping work-piece. Ex1) Attachment made by an elastic material. Ex2) Change the point of a rod where force is applied to the same axle.  <If it is not possible to change the shape of attachment> The unstable pushing condition cannot be improved. <How to reduce the instability of the "Output signal"> 1. To reduce the influence when pushing the work piece. "Pushing force" = "TriggerLV" 2. Set the pushing force to be larger within the specified range.  An unstable output signal may occur easily because of an external shock or vibration when the pushing force is set too low.
	"INP" output signal is unstable. "INP" output signal is unstable even after the positioning operation is completed.	1) The value of [In position] in step data is too small	Increase [In position] value as the following.  ( [0.5] or more )
	"INP" output signal is [OFF]. "INP" output signal is [OFF] even after the pushing operation is completed.	The value of "In pos" is input forward of work.	Input the value of "In pos" larger than length to work.  /See Example of step data entry(4) on p.28
4	Positioning repeatability is out of specified range.	1) It shifts to the next operation by receiving the "INP" output signal.	Go to the next operation after receiving the "BUSY" output signal is outputted.
		2) The belt is loosened.	Readjust belt tension to the appropriatede value.  /See 7.5 Replacement of belt on p.47
5	Damage	1) Abnormal external force	Interference of mechanism, eccentric load or excess load leads to cause deformation or damage of the actuator. Eliminate these factors.
6	The rod of the actuator with vertical mounting vibrates repeated up and down.	1) Actuator carries excess load.	Check if the workload is within the specification range.  /See 2.1 Specifications on p.9 /See 3.1 Specifications on p.13

No.	Phenomenon	Cause	Countermeasure
7	Cannot be actuated manually or by manual override adjustment screw (does not operate). (At stop(EMG) or SVRE[OFF])	1) Contacts the stroke end of the actuator or the workpiece.	Check the stroke position and how workpieces are mounted.
		2) [Lock type] is selected	Supply 24VDC power supply to the [BK RLS] terminal of controller/CN1 power supply plug in order to unlock. /see 6.6 Precautions for the actuator with lock  Warning(7)
	Lock type is selected, but workpieces are dropped during stopping(EMG) or SVRE[OFF], or moved by external force.	1) Load exceeding the maximum work load is mounted, or external force more than the lock holding force is applied.	Check the mounted load and lock holding force to confirm if they are within the operation range. /see 2.1 Specifications/LEY on p.9 /see 3.1 Specifications/LEYG on p.13
		2) 24VDC is supplied to "BK RLS" terminal of controller/CN1 power supply connector.	Stop supplying 24VDC power supply to the [BK RLS] terminal /see 6.6 Precautions for the actuator with lock  Warning(8) on p40

#### revision history

No.LEY-OM00201

Jun / 2009 1st printing

No.LEY-OM00202

Apr/ 2010 Revision

- Addition / LEYG Series (Guide rod type)

No.LEY-OM00206

Aug / 2010 Revision

- Addition / LEY\_D (In-line mounting type)

No.LEY-OM00207

Mar / 2011 Revision

- Addition / LEYG\_D (In-line mounting type),  
LECP1

## SMC Corporation

4-14-1, Sotokanda, Chiyoda-ku, Tokyo 101-0021 JAPAN

Tel: + 81 3 5207 8249 Fax: +81 3 5298 5362

URL <http://www.smcworld.com>

Note: Specifications are subject to change without prior notice and any obligation on the part of the manufacturer.

© 2010 SMC Corporation All Rights Reserved